

Figure 01 Four lines used in SUS

			
<p>(a) Horizontal line at the middle</p>	<p>(b) Half vertical line to be placed at 4 locations</p>	<p>(c) Small vertical line to be placed at 4 locations</p>	<p>(d) Small horizontal line to be used above or below.</p>

Figure 02 Locations of moving lines in SUS

		
<p>(a) 4 locations for half vertical line Movement - Clock-wise</p>	<p>(b) 4 locations of small vertical line Movement - Clock-wise</p>	<p>(c) 2 locations of small horizontal line</p>

Figure 03 Scripts of Group heads of SUS



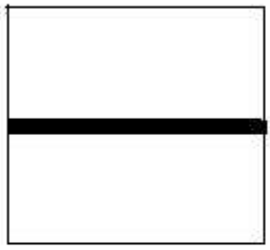
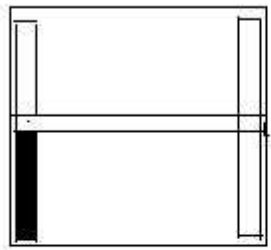
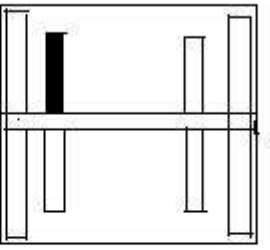
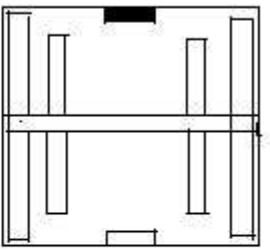

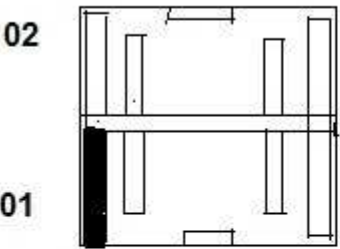
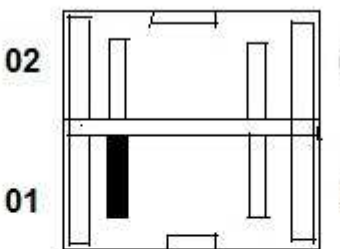
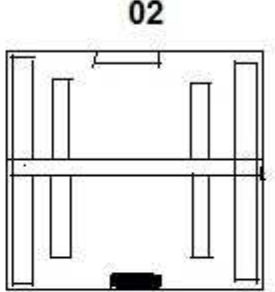

				
(01) Vertical line placed at 1	(02) Vertical line placed at 2	(03) Vertical line placed at 3	(04) Vertical line placed at 4	(05) Combining 1 & 2
				
(06) Combining 1 & 3	(07) Combining 1 & 4	(08) Combining 2 & 3	(09) Combining 2 & 4	(10) Combining 3 & 4
				
(11) Combining 1,2 & 3	(12) Combining 1,2 & 4	(13) Combining 1,3 & 4	(14) Combining 2,3 & 4	(15) Combining 1,2,3 & 4

Figure no. 04 ENGLISH SUS SCRIPT

	ENG	SUS	ENG	SUS	ENG	SUS	ENG	SUS	ENG	SUS
01	a	┌	b	┌	c	┌	d	┌	e	┌
02	f	┌	g	┌	h	┌	i	┌	j	┌
03	k	┌	l	┌	m	┌	n	┌	o	┌
04	p	┌	q	┌	r	┌	s	┌	t	┌
05	u	┌	v	┌	w	┌	x	┌	y	┌
06	z	┌								

Figure 05 Arabic letters in SUS script

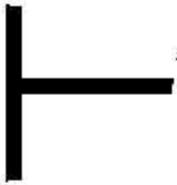
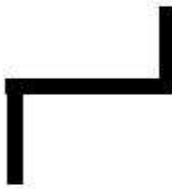
Letters (28 nos.)					
4	3	2	1	Group head No.	
ج jīm	ث thā	ط pa	ب bā	ا lif	Arabic
ج	ث	ط	ب	ا	SUS
ر rā	ذ dhāl	د dāl	خ khā	ح ḥā	Arabic
ر	ذ	د	خ	ح	SUS
ض dād	ص ṣād	ش shīn	س sīn	ز zāy	Arabic
ض	ص	ش	س	ز	SUS
ف fā	غ ghayn	ع ayn	ظ zā	ط tā	Arabic
ف	غ	ع	ظ	ط	SUS
ن nūn	م mīm	ل lām	ك kāf	ق qāf	Arabic
ن	م	ل	ك	ق	SUS
Jer	Jabar	ي yā	و waw	ه hā	Arabic
Jer	Jabar	ي	و	ه	SUS
MODIFIERS – 9 nos. (Arabic symbols not shown)					
Sakin	Double Pesh	Double Jer	Double Jabar	Pesh	Arabic
س	س	س	س	س	SUS
				Jajam	Arabic
				ج	SUS

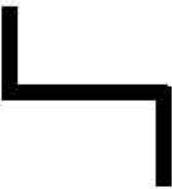
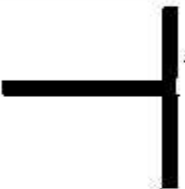
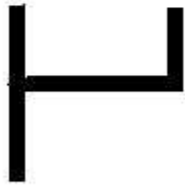
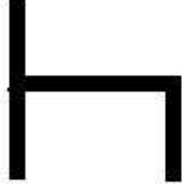
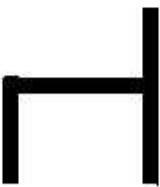
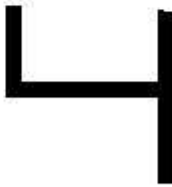
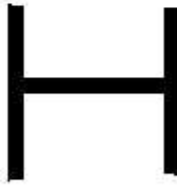
Figure 06 Bengali scripts and signs in SUS

Sl. No.		Group heads	1	2	3	4
01	Bengali script	ক (ka)	খ (kha)	গ (ga)	ঘ (gha)	ঙ (uma)
	SUS	┌	┌	┌	┌	┌
02	Bengali script	চ (cha)	ছ (chha)	জ (ja)	ঝ (jha)	ঞ (mio)
	SUS	└	└	└	└	└
03	Bengali script	ট (Ta)	ঠ (Tha)	ড (Da)	ঢ (Dha)	ণ (Na)
	SUS	┌	┌	┌	┌	┌
04	Bengali script	ত (ta)	থ (tha)	দ (da)	ধ (dha)	ন (na)
	SUS	┌	┌	┌	┌	┌
05	Bengali script	প (pa)	ফ (pha)	ব (ba)	ভ (va)	ম (ma)
	SUS	┌	┌	┌	┌	┌
06	Bengali script	য (ja)	র (ra)	ড় (rha)	ঢ় (RHa)	ল (la)
	SUS	┌	┌	┌	┌	┌
07	Bengali script	য় (ya)	স (sa)	শ (sha)	ষ (SHa)	হ (ha)
	SUS	┌	┌	┌	┌	┌
08	Bengali script	অ (o)	ক্ষ (kkyo)	ৎ (t)	ঃ (-h)	ঁ (-n)
	SUS	┌	┌	┌	┌	┌
09	Bengali script	আ (u)	ই (i)	ঐ (ee)	উ (u)	ঊ (oo)
	SUS	┌	┌	┌	┌	┌
10	Bengali script	ঋ (Ri)	এ (e)	ঔ (oi)	ও (o)	ঔ (Ou)
	SUS	┌	┌	┌	┌	┌
11	Two special signs	(01) Sign of association	(02) Sign of dissociation			
		— (plus)	+ (minus)			