

Table of Contents

Chapter 1.0 Introduction	3
1.1.0 Wave energy.....	3
1.1.2 Reasons for Energy	3
1.1.3 UK wave energy resource.....	4
1.2.0 The device	6
1.2.1 Point observer	6
1.2.1 The Device and parts.....	7
Figure 1.5 Prototype of the device	7
1.2.2The principle of the wave energy convertor	8
1.3 Planting	11
Chapter 2.0 Literature review.....	13
2.1.0 Introduction of wave.....	13
2.1.1 Wave motion	13
2.1.2 Wave energy.....	15
2.1.3 Power extraction from wave	17
2.2.0 Archimedes' principle and the laws of floatation.....	19
2.3.0 The metacentric height	19
2.4.0 Motion equation.....	19
2.5.0 Power transmission system.....	20
3.0 Design and calculation.....	21
3.1.0 Introduction of the buoyance design.....	21
3.1. 1 Shape section.....	22
3.2 Design calculation.....	23
3.2.1 Calculation of Central of gravity	23
3.2.2 Calculation of metacentre.....	25
3.3 Calculation result	26
4.0 Test methodology.....	29
4.1.0 Background.....	29
4.1.1 Test matrix.....	29
4.2 Pre- Setup.....	30
4.3 Setup and trial test	31
5.0 Data analysis	33

5.1.0 Introduction of data and over view	33
5.2 ANOVA	34
5.2.1 Further discussion.....	38
5.3 Mathematical modelling	39
6. 0 Discussions	44
6.1.0 Comparison	44
6.2.0 Mechanical loss	45
6.2.0 Design issues	45
6.2.1 Roping issues.	45
6.2.2 Protecting issues.....	47
6.2.3 Weight issues.....	47
6.2.4 Flotation platform issues.....	49
Chapter 7.0 Conclusions	51
8.0 Recommendation	52
Equation of wave motion sheets	53
Reference:	54

Chapter 1.0 Introduction

1.1.0 Wave energy

Ocean wave energy is a natural source of energy, which caused by the wind. When wind blows across the sea surface, the energy wind energy transfers to waves through friction between the air molecules and the water molecules, and the size of the waves are depended on the wind speed, wave duration, and the distance of water over which it blows (the fetch), bathymetry of the seafloor (which can focus or disperse the energy of the waves) and currents. The movement of water carries kinetic energy to provide the mechanical input for the wave energy devices.

The location of the best wave energy resource would have characteristics of area strong wind which has travelled over long distances, essential on this factor western coasts of Europe which lie at the end of a long fetch (the Atlantic Ocean) have one of the best wave resources of the world. Wave energy reduces by friction against the seabed, where the location is closer to the coastline that implies waves in the deep sea contains more energy.

Marine energy can be divided in to two types, Thermal Ocean Energy and Mechanical Ocean energy, and waves are a powerful source. Mechanical ocean energy splits in to different mechanical systems which can produce electricity from ocean energy. These are the three main types of systems.

- The channel systems, funnel the sea water into reservoirs.
- The float systems, wave are used to drive or run the hydraulic pumps.
- The column systems, waves compress the air present within the containers.

1.1.2 Reasons for Energy

Wave energy has significant global potential throughout the world, USA, North & South America, Western Europe, Japan, South Africa, Australia and New Zealand all these countries ave a high potential wave energy sites around them.

A study from The World Energy Council has estimated by ocean wave energy only could generate approximately 2 terawatts (2 million megawatts), which is about twice the current world electricity production. They also estimated there is about 1 million gig watt hours of wave energy hits Australian shores annually, and that 25% of the UK's current power usage could be supplied wave resource.

Wave energy is one of the most environmental friendly ways to electricity production. Wave is a clean and renewable energy source with high concentrated energy, and there are plenty of benefits from wave energy:

- Wave is relatively constant compare with wind and solar energy, i.e. wave are more efficiency. Therefore ocean wave energy can supply continuous electricity throughout the year.

- Approximately 72% of the planet's surface is ocean, is the resource most countries can be reach easily and benefit from it, also wave energy can help to security the energy supply.
- Waves can be projected few days in advance by using satellite measurements; we can get a high level of predictability from the meteorological forecasts.
- Waves are produced over great regions of sea and travel huge distances without a high amount of energy losses.
- Even though wave energy is a concentrated energy source of wind energy but it also travel a very great distance, therefore wave is often out of phase with the local wind speed. Wave energy can therefore help to stability output variability from other renewable sources and maximise the use of electricity networks.

1.1.3 UK wave energy resource

A research by carbon trust review that The United Kingdom with its long exposure to the Atlantic has some of the best wave resources found anywhere, but not all the energy can be transfers into electricity production. From the result Carbon trust divided the wave energy resource around the UK into the bellowing 4 characters.

- **Total Resource (TWh/y):** The total resource arriving in UK waters. It is the total resource flowing over a single frontage (or group of frontages) that are arranged to give the highest overall energy availability to the UK. These frontages do not take into account potential location constraints such as water depth and distance to shore.
- **Theoretical Resource (TWh/y):** The maximum energy available from a set of frontages positioned in realistic locations based on areas likely to have the most competitive low cost of energy.
- **Technical Resource (TWh/y):** The energy available from the theoretical frontages using envisaged technology options.
- **Practical Resource (TWh/y):** The proportion of the technical resource that can be extracted taking into account locations constraints such as sea uses and environmental impacts.

Table 1.0 below shows is the Summary of resource estimation of offshore and near shore wave energy farms. Despite the estimated resources had been reduce massively from the total of 230 [TWh/y] for both offshore and near shore to 70[TWh/y] for offshore, and 5.7[TWh/y] for near shore. It still shows the high protein of wave energy within the UK's Exclusive Economic Zone.

Table 1.0 Summary of resource estimates for offshore and near shore wave energy farms

	Off shore		Near shore	
	Annual energy [TWh/y]	Mean power [GW]	Annual energy [TWh/y]	Mean power [GW]
Total	230	26	230	26
Theoretical	146	18	133	15
Technical	95	11	10	1
Practical	70	8	5.7	0.6

Another research done by the Crown Estate shows that, the high majority of the UK wave resource concentrated within the Scottish waters, and there are also significant resources off southwest England and Wales. The distribution is show in table 1.1 below.

Table 1.1: Distribution of wave energy resources across the UK

Location	Indicative annual energy [TWh/year]	Indicative maximum power [GW]
England and Wales	23	8.7
Scotland	46	18
Total	69	27

Figure 1.0 Annual mean wave power- Full wave field

Figure 1.0 above provided by Atlas of UK Marine Renewable Energy Resources and public in 2008, the map clearly shows that the mean power near shore around England is around 5.1 < 10 KW/m and power are Scotland and south west England could get up to 15.1 < 20 KW/m. The result also reflexed most of the wave energy devices are locating in Scotland area, and £103m funded by the Marine Renewables Commercialisation Fund (MRCF) for marine energy in Scotland.

1.2.0 The device

1.2.1 Point observer

This wave energy converter we are integrating with is a point observer. Reference by EMEC (European Marine Energy Centre), the definition of a point observer is a floating structure which absorbs energy from all directions through its movements at/near the water surface. It converts the motion of the buoyant top relative to the base into electrical power. The power take-off system may take a number of forms, depending on the configuration of displacers/reactors. AWS Ocean Energy Ltd is one of the developers which had been working on the point observer.

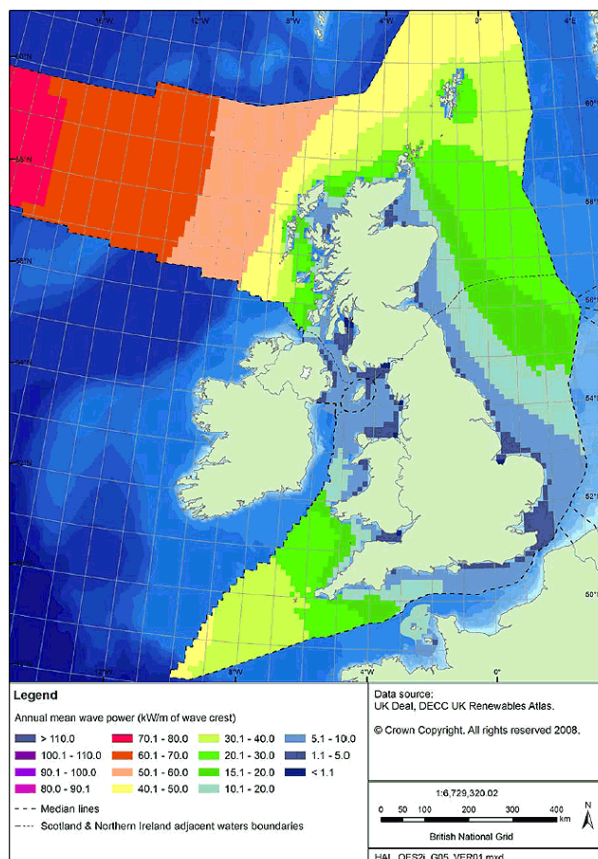
AWS Ocean Energy Ltd

AWS Ocean Energy is a Scottish company established to commercialise the Archimedes Wave Swing or “AWS” wave energy technology

Figure 1.4 the concept idea of the AWS wave energy convertor farm



AWS Ocean Energy had made a point absorber device. This floating device can absorb energy from any directions of the waves. It converts the wave surface up and down motion into the electrical power by using a linear generator. These are the features of the AWS wave energy convertor.

- Relative movement of the two parts of the device is converted directly to electricity by a linear generator
- Resonant system that can be tuned to predominant waves
- First commercial units rated at 1.25MW – sufficient to power 625 homes – large wind turbine equivalent
- Utility scale, high efficiency, simple, robust design, minimal maintenance

1.2.1 The Device and parts

The figure 1.5 below shows the prototype of the device. The prototype built to shows the basic concept of this device. The device divided into three parts, dry, semi submerged and fully submerged, and each part has its own component.

- **Dry part** has 12 inch wheel spoke onto a bicycle hub with a pair of bicycle flywheels on each end. The wheel also connected to a generator by a belt which all fixed on an outer frame.
- Semi submerge part included a floating foam with a thin layer of pinewood covered the top to prevent the bending of the foam after the dry part placed on it, and a pair of chain that connected with the flywheels and loading weights.
- **Fully submerge part** is a pair of free (or loading) weights and the dominated weight which hold the device in place.

Figure 1.5 Prototype of the device

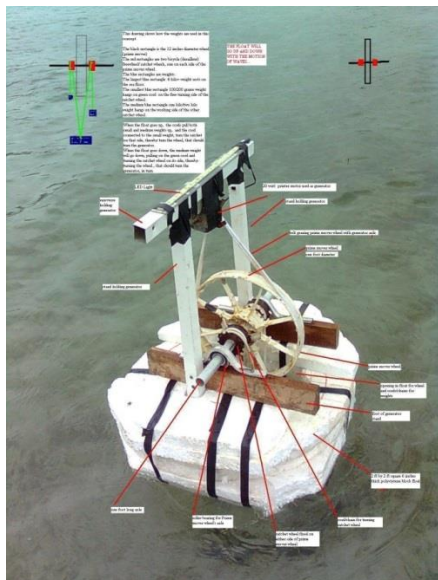

The figure 1.6 below is the modified version of the device. Rectangular shape buoyancy has purposely selected for the test. All the tapes had removed. Instead of placing the bicycle hub on a piece of wood, it's now mounted on the outer frame. The right hand side of the picture shows the submerged part of the device.

Figure 1.6

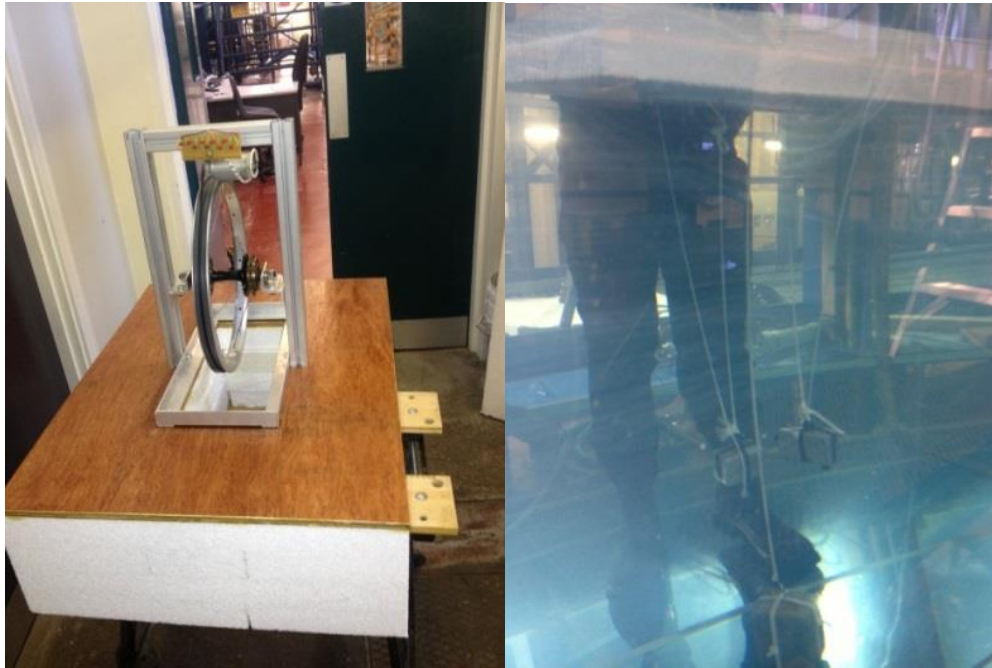

1.2.2 The principle of the wave energy convertor

Any floating object on water has 6 degree of freedom which are pitching, yawing, rolling, heaving, swaying and surging. For this device, it requires heave motion to power the generator (see chapter 2.2 for heave motion). The ideas for this convertor are, when a wave passed through the device would follow the motion of water and move up and down, hence drive the wheel and generate power.

Figure 1.7 below demonstrates the layout of the device at an equilibrium position. Here, the dominated weight is sitting at the seabed; it connected to the loading weights which placed onto the fly wheels. Since the dominate weight is heavier than the free weights, it will at the same position.

Figure 1.7 Equilibrium position

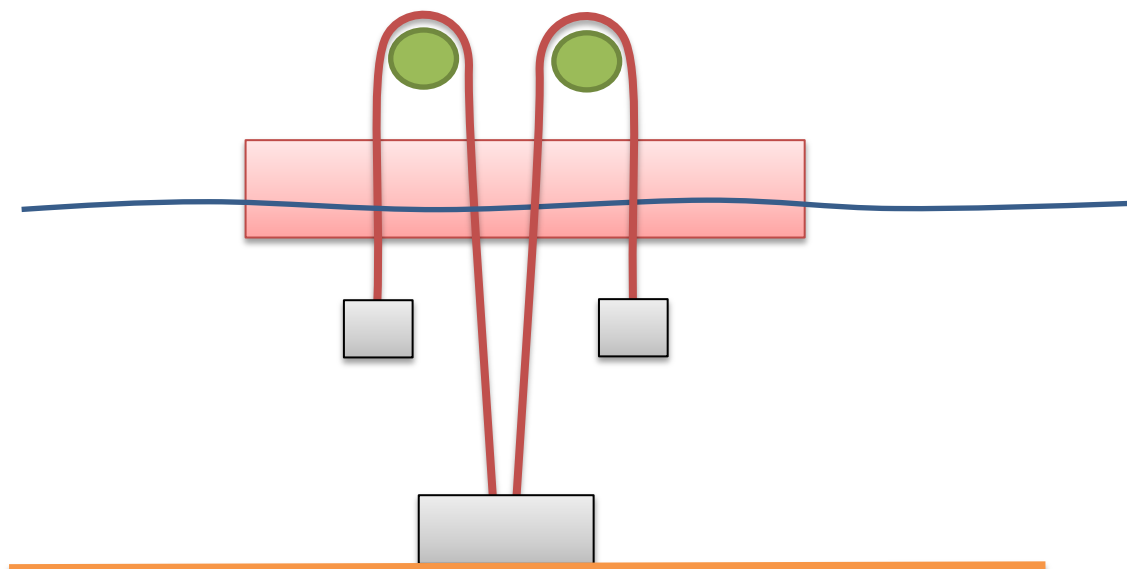

Figure 1.8 is representing the force acted on the device with a coming wave. Imagine the device works like a pair of pulleys. As a wave come the up force acted on the free wheel increase, and the downward force acted on the dominate weight will also increase, due to the loss of upward force from seabed. I.e. the downward force on the free weight is a lot smaller than the dominate weight, I.e. created a pulling force to turn the free wheel, hence drive to generate power

Figure 1.8 Water rising

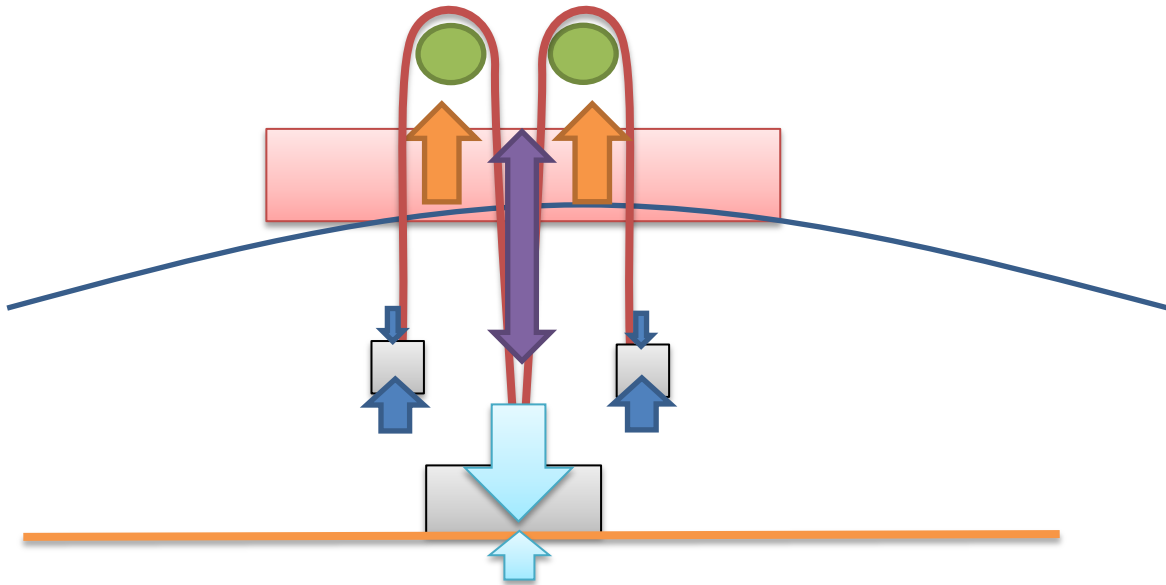
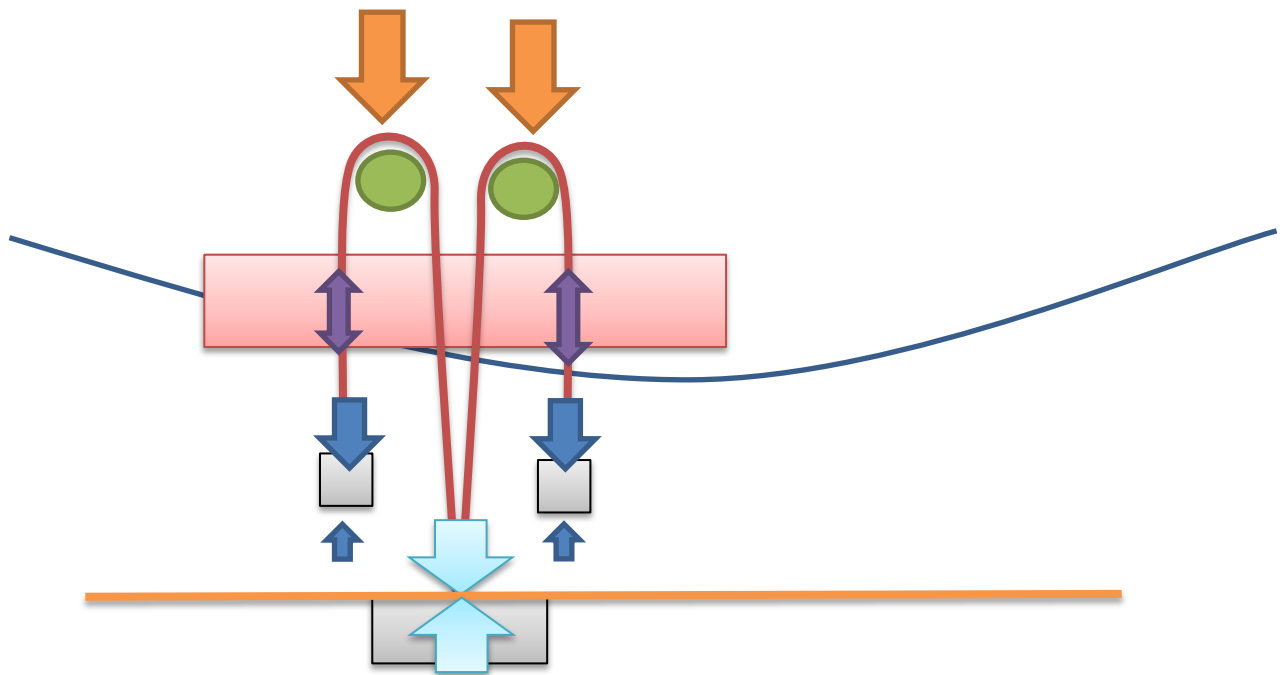

Figure 1.9 is illustrating the force acted on the device with a passed wave. The upward force from the seabed regained on the dominate weight. This mean the tension between the fly wheel and the dominate weight reduced. The total downward force of the free weights is greater that the dominate weight, i.e. the released tension will gain back on the free weights, to keep the device in an equilibrium position. This also turns the free wheel and produce electricity.

Figure 1.9 Water falling



Representing the force acting on the free weight



Representing the force acting on the buoyance



Representing the force acting on the dominate weight



Representing the direction of the pulling

1.3 Planting

Platform design: Design the buoyancy for the device, which is able to support the device with range of regular waves.

1. Shape selection
2. Measure the size of the device
3. Buoyancy calculation
4. Size selection
5. Draw out the final design

Preparation before - experiment:

1. Data collection (information of the tank)
2. design a test matrix
3. prediction

Data analysing:

1. statistical modelling
2. mathematical modelling
3. Investigation on how the device will behave with different frequencies and wave height.

Discussion

1. Expecting when the device works with high amplitude.
2. The device doesn't go well with any frequencies.
3. That is the interesting point for further investigation.

Predictions

Basic calculation for the generator shaft speed, assume there are zero losses and regular wave condition. Imagine the device is sitting on the surface of the water, as a wave come, it will follow the wave motion, and therefore the vertical distance the device is traveling is $2a$.

Let say the Period for the wave is T , the whole period of wave will travel the vertices direction twice, i.e. the speed = distance over time, which gives us $m/s = 4a/T$. Hence $T=1/\text{frequency}$, therefore we can rearrange the formula as speed = $4a/f$.

If here are no losses, the vertical speed will be equal to the rotation speed on the flywheel, therefore the angular velocity for the flywheel is $\omega = \text{speed time times radius}$. The radius diameter of the flywheel is $0.07m$, $\omega = 0.035/4af$. The wheel has the diameter of 12 inch, which is about 0.3048 metres. Since it connected to the flywheel, and under our assumption, the wheel would travel in the same angular velocity as well, therefore the velocity that turns the generator would be $\text{wheelspeed} = 0.0354a / (f \cdot 0.3048)$.

Response to the frequency

With the frequency of 0.25 Hz to 0.5 Hz, the total vertical displacement of the wave would be relatively short, imagine the displacement is proportional to turning distance of the wheel, which is directly proportional to the electricity outcome.

When the frequency at 0.75 Hz, the wave will provide a free fall the device, and provide strong heave motion for the device; therefore the device is expecting a well response in the medium frequency.

The frequencies of 1 Hz and 1.25 Hz, might have the highest displacement of the wave but the device might sit on top of the wave peak, therefore, not much heave motion, hence the vertical displacement for device would be reduce to minimum and we are expecting a very low response from the device.

Behaviour with different size of the platform

With a bigger platform, it will have a better buoyancy and stability, less rocking movement, the device. Therefore it might convert more up force should be than the potential energy of the wave.

Behaviour with different size of the load

This is fairly hard to predict, with more weight it will reduce the buoyancy but increase the torque, we should get a pretty good result from the bigger buoyance with the heavier load. I.e. good up thrust force and torque.

Chapter 2.0 Literature review

2.1.0 Introduction of wave

Water wave can be represented as a sinusoid wave see figure 2.0 below.

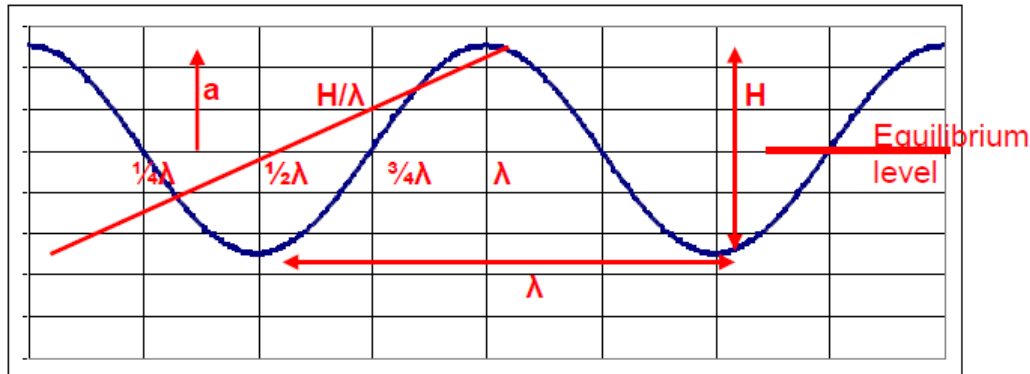

The parameters and definitions:

- **a**, the amplitude (m), is the vertical displacement between the wave peak and the equilibrium level of the water
- **H**, the wave height (m), is the vertical distance between the peak and the trough of the wave. H is twice the value of the amplitude
- **λ**, the wavelength (m), is the horizontal distance between two successive wave peaks (or between two successive wave troughs)
- **H/λ**, the wave steepness is a dimensionless parameter which would not normally exceed 0.1. A high value of wave steepness implies 'choppy' water

Further parameters used in defining waves are the wave number, **k**, in m⁻¹:

- **T**, wave period (s), time it takes for two wave crests to pass a given point.
- **ω**, angular frequency (rads⁻¹), which is $2\pi/T$
- **k**, wave number(m⁻¹), equal $2\pi/\lambda$

Speed of wave can be define as **c**, the formula for calculating **c** is

$$c = \left(\frac{g\lambda}{2\pi}\right)^{\frac{1}{2}} = \frac{gT}{2\pi} \quad (2.10)$$

2.1.1 Wave motion

This paper is writing an investigation about a wave energy convertor behave, but before any further study for the wave energy device. We need to know how waves behave. Water wave is a Mechanical Waves, they need medium to travel or to transfer the energy from one place to another is mechanical waves. Ocean waves are a good example for mechanical wave.

Ocean waves are energy transmit from one point to another point by using water as a (liquid) medium. There are two main types of mechanical waves.

Transverse Waves: wave the particle displacement is perpendicular to the direction of wave propagation. Figure 2.0 below illustrates when waves travel in a one-dimensional transverse plane and waves is propagating from left to right. The water particles do not move along with the wave instead the particle just oscillate up and down about their individual equilibrium positions as the wave passes by.

Figure 2.0

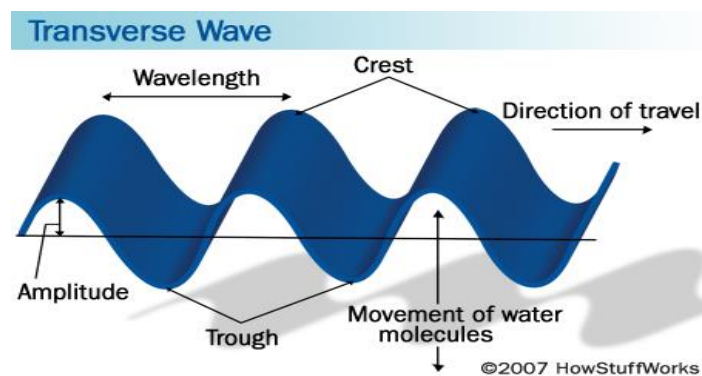

Longitudinal Waves: wave the particle movement is parallel to the direction of wave propagation. Figure 2.1 shows that the particles do not process along with the wave. They simply oscillate back and forth about their individual equilibrium locations. The wave is seen as the motion of the compressed region, which moves from left to right.

Figure 2.1

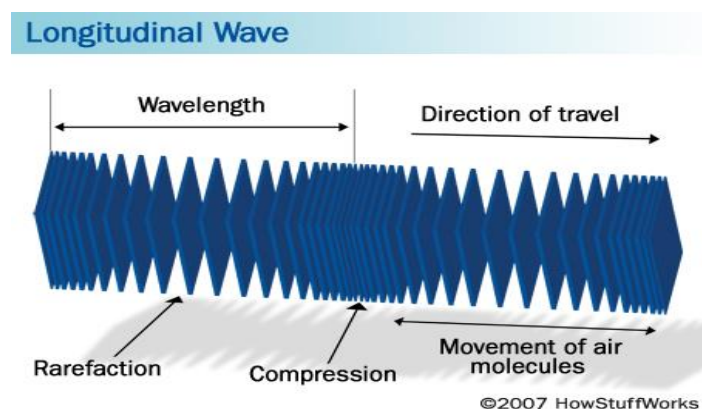

Water particle moves in a circular and water waves are combination of both longitudinal and transverse motions. Whereas the surface form of the wave shows a definite progression, the water particles themselves have no net progression. Hence the particle on the surface remains their position. An animation of wave particles is available at the link below (<http://www.acs.psu.edu/drussell/Demos/waves/Water-v8.gif>). Accessed July, 2013

The amplitude of the water particle motions decrease exponentially with depth. The amplitudes of the water particle motions decrease exponentially with depth. At a depth of $\lambda/2$ below the mean surface position, the amplitude is reduced to $1/e$ of the surface amplitude. The particle motion remains circular if the sea bed depth $D > 0.5\lambda$, when the amplitude becomes negligible at the sea bottom. A water particle whose mean position below the surface is z moves in a circle of radius given by

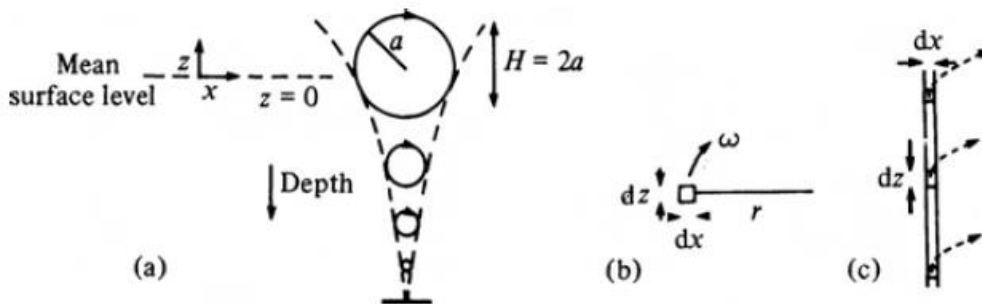

Radius of the circular orbits is,

$$r = ae^{kz} \quad (2.11)$$

Where r , a is the wave amplitude, k is the wave number and z is the depth from surface to sea bed

2.1.2 Wave energy

Wave energy is the combination of the kinetic energy and Potential energy of wave the total energy can be represent as

$$E = Ek + EP \quad (2.12)$$

The equation for Kinetic energy is

$$Ek = \frac{1}{2} mv^2 \quad (2.13)$$

Consider the wave is now broken down in to small columns, therefore the position of (x, z) can he written as 'length' dx and 'height' dz . We know that mass = volume (V) x density (ρ), the formula for changing mass can be written as

$$dm = \rho dV = \rho dx dz \quad (2.14)$$

By substitute equation (2.14) in to (2.13), contribution of the kinetic energy in a vertical column for the surface of the water to the sea bed is $\delta Ek dx$,

$$\delta Ek dx = \frac{1}{2}mv^2 = \frac{1}{2}(\rho dz dx)r^2\omega^2 \quad (2.15)$$

Hence,

$$\delta EK = \frac{1}{2}\rho r^2\omega^2 dz \quad (2.16)$$

So by substituting the equation 2.10, we get

$$\delta EK = \frac{1}{2}\rho(a^2 e^{2kz})\omega^2 dz \quad (2.17)$$

To get the total energy of the column, we can integrate δEK with respect with z ; since z is the displacement under water surface therefore the limit is between $-\infty$ to 0

$$Ek dx = \int_{z=-\infty}^{z=0} \frac{\rho\omega^2 a^2}{2} e^{2kz} dz dx = \frac{1}{4k}(\rho\omega^2 a^2)dx \quad (2.18)$$

From section 2.1 we know, $k = 2\pi/\lambda$, $\omega^2 = 2\pi g/\lambda$ and substitute in to (2.18) we get

$$Ek = \frac{1}{4} \frac{\rho a^2 2\pi g}{\lambda} \frac{\lambda}{2\pi} = \frac{1}{4} \rho a^2 g$$

Potential energy

$$Ep = \frac{1}{4} \rho a^2 g$$

Therefore

$$E = Ek + EP = \frac{1}{2} \rho a^2 g$$

The energy per unit wavelength in the direction of the wave, per unit width of wave front, is

$$E_\lambda = \frac{1}{4\pi} \rho a^2 g^2 T^2$$

2.1.3 Power extraction from wave

The vertical displacement from the average position

$$\Delta z = r \sin(\omega t) = a e^{kz} \quad (2.3.1)$$

The horizontal speed u_x is given

$$u_x = r \omega \sin(\omega t) = \omega a e^{kz} \sin(\omega t) \quad (2.3.1)$$

The power carried in wave at x , per unit width of wave-front at instant, is given

$$P = \int_{z=-\infty}^{z=0} (p_1 - p_2) u_x dz \quad (2.3.2)$$

Where p_1 and p_2 are the locate pressures experienced across the element of height dz and unit width across the wave front. Thus $(p_1 - p_2)$ is the pressure difference experienced by the element of width $\Delta y (= 1m)$ in a horizontal direction. The only contribution to the energy flow that done not average to zero at a particles rotating in the circular paths, therefore by conservation of energy

$$p_1 - p_2 = \rho g \Delta z \quad (2.3.3)$$

Substituting for Δz

$$p_1 - p_2 = \rho g a e^{kz} \sin(\omega t) \quad (2.3.4)$$

Sub in

$$P = \int_{z=-\infty}^{z=0} (\omega a e^{kz} \sin(\omega t)) (\rho g a e^{kz} \sin(\omega t)) dz \quad (2.3.5)$$

$$P = \rho g a^2 \omega \int_{z=-\infty}^{z=0} e^{kz} \sin(\omega t) dz \quad (2.3.6)$$

The time average over many periods of $\sin^2 \omega t$ equals $\frac{1}{2}$, therefore

$$P = \frac{\rho g a^2 \omega}{2} \int_{z=-\infty}^{z=0} e^{kz} dz = \frac{\rho g a^2 \omega}{2} \frac{1}{2k} \quad (2.3.7)$$

The phase velocity of the wave is,

$$c = \frac{\omega}{k} = \frac{\lambda}{T} \quad (2.3.8)$$

So the power carried forward in the wave per unit width across the wave front becomes

$$P = \frac{\rho g a^2}{2} \frac{c}{2} = \frac{\rho g a^2 \lambda}{4T}$$

From (12.23) and (12.37) the power P equals the total energy (kinetic plus potential) E in the wave per unit area of surface, times $c/2$. $c/2$ is called the group velocity of the deep water wave, i.e. the velocity at which the energy in the group of waves is carried forward. Thus, with the group velocity $u = c/2$,

$$P = Eu = \frac{Ec}{2} \quad (2.3.9)$$

$$\text{Where } E = \frac{\rho g a^2}{2}$$

$$k = \omega^2 / g \quad (2.3.10)$$

Therefore, the phase velocity is

$$c = \frac{\omega}{k} = \frac{g}{\omega} = g / \left(\frac{2\pi}{T} \right) \quad (2.3.11)$$

This difference between the group velocity and the wave (phase) velocity is common to all waves where the velocity depends on the wavelength. Such waves are called dispersive waves and are well described in the literature, both descriptively

$$P = \frac{\rho g a^2}{2} \frac{1}{2} \left(\frac{gT}{2\pi} \right) \quad (2.3.12)$$

Hence

$$P = \frac{\rho g^2 a^2 T}{8\pi} \quad (2.3.13)$$

(Reference, Twidell)

2.2.0 Archimedes' principle and the laws of floatation

Archimedes' principle states that the upward buoyant force exerted on a body either fully or partially immersed in a fluid, is equal to the weight of the fluid that the body displaces.

Formula for Buoyancy

$$F_{\text{buoyance}} = g * \rho * V$$

Where

- F_{buoyance} is the buoyance force on the object.
- G is the acceleration due to gravity.
- ρ is the density of the fluid (i.e. 1000 kg per m³ for fresh water)
- V is the volume of the body immersed in a fluid

2.3.0 The metacentric height

The metacentric height (GM) is a measure of the initial static stability of a floating body. It is computed as the length between the centre of gravity of an object and its metacentre. A larger metacentric height means higher initial stability against overturning. Metacentric height also has implication on the natural period of rolling of a hull, with rather large metacentric heights being correlated with shorter periods of roll which are uncomfortable for passengers. Hence, a sufficiently high but not extremely high metacentric height is considered ideal for passenger ships.

2.4.0 Motion equation

Equation of free heaving motion: This takes place in absence of waves.

$$(M + M_a)\ddot{z} + b\dot{z} + cz = F_0 \cos(\omega t)$$

The first, second and the third term in the above equation represent the inertial, damping and the restoring force, respectively.

a = inertial coefficient, b = damping coefficient, c = restoring force coefficient, z , \dot{z} and \ddot{z} = vertical displacement, velocity and acceleration respectively of the ship.

The vertical motions are evaluated with respect to the CG.

The inertial coefficient is also called virtual mass and it has two components: Actual ship mass and the added mass.

2.5.0 Power transmission system.

Belt Drive When a belt is used for power transmission it is called a belt drive Belts are the cheapest utility for power transmission between shafts that may not be parallel. Power transmission is achieved by specially designed belts and pulleys. Belts run smoothly and with little noise, and cushion motor and bearings against load changes, but have less strength than gears or chains.

Advantages

Cheap

- Allows misalignment (parallel shafts)
- Protects from overload
- Absorbs noise and vibrations
- Cushion load fluctuations
- Needs little maintenance

Disadvantages

- Speed ratio is not constant (slip & stretch)
- Heat accumulation
- Speed limited – 2000 m/min,
- Power limited - 700 kW
- Endless belts needs special attention to install

3.0 Design and calculation

3.1.0 Introduction of the buoyance design

In this section, we will look into the design of the buoyant for this wave energy convertor. Figure 3.0 from below shows the dry (or mechanical) part of the device been mentioned in section 1.4. The purposes of the buoyant are to support the device with a range of regular waves and allow the device to move in the heave motion.

Figure 3.0 Dry part of the Device



Dimension and scale of the device

The dry part of the device has weight of 2.8 Kg; the dimension of the outer frame has height 0.4m, width 0.173m and length 0.363m.

3.1. 1 Shape section

Since this experiment is the primary experiment for this device, so it's better to start with a basic shape, and see how it behaves. 3 shapes have selected triangle, circle and rectangle. The best way to select the best shape, we can look the advantage and disadvantage for each shape.

Circle

Advantages	Disadvantages
<ul style="list-style-type: none"> • Accept wave come from all direction. • Easy to make • The device is able to sit in the centre easily • Minimize the water impact against the platform. 	<ul style="list-style-type: none"> • Extra equipment or design required for facing the wave •

Triangle

Advantages	Disadvantages
<ul style="list-style-type: none"> • Allow the device to face the wave • Similar to a boat shape, more information can be finding. • it has the stronger structure 	<ul style="list-style-type: none"> • Only allow on side facing the wave at time • Require a lots of calculation for angles • Require a maximum of 180 degrees turn if the wave come from opposite direction

Rectangle

Advantages	Disadvantages
<ul style="list-style-type: none"> • Able for face the way in 2 directions • Easy to make • Simplify the calculation • Allow water to get pass always facing the direction. • The device is able to sit in the centre easily • Only require a maximum of 90 degrees turn if the wave come from a horizontal direction • Base of the device is also rectangle 	<ul style="list-style-type: none"> • The side of the platform will have a big impart with water.

Base on the result from above, rectangle is the best shape to be the platform

3.2 Design calculation

3.2.1 Calculation of Central of gravity

To simplify the calculation, all the material assumed the densities of mass for all the objects are homogenously distributed. I.e. the centroid (G) of the foam will be half of it height (H_f). Hence,

$$\text{Centroids} = H_f/2. \quad (3.0)$$

From section, 1.2 stated if the device place on the floating foam it needs to add a thin layer of pinewood on the foam for increase its strength, and proven to bending of the foam. However by adding the pinewood would affect the centroid. In other words, the centroid of the buoyant now transferred to a higher position G1. Let HW be the thickness of the pinewood, centroid of the pinewood would be HW/ 2. By applying the formula below, we can work out the distance between G and G1

$$GG1 = w * d / (\text{Total mass}) \quad (3.1)$$

w is the mass of the pinewood, which has a density of 530 kg/m³. d is the distance between the centroids of, and the centroids of wood. This give $d = H_f / 2 + HW/2$. As it mentioned before, the extra mass was adding on top of the foam, now G1 located at an upper position given be G+GG1. See figure 3.1 below.

Figure 3.1 the centroids of the foam and pinewood

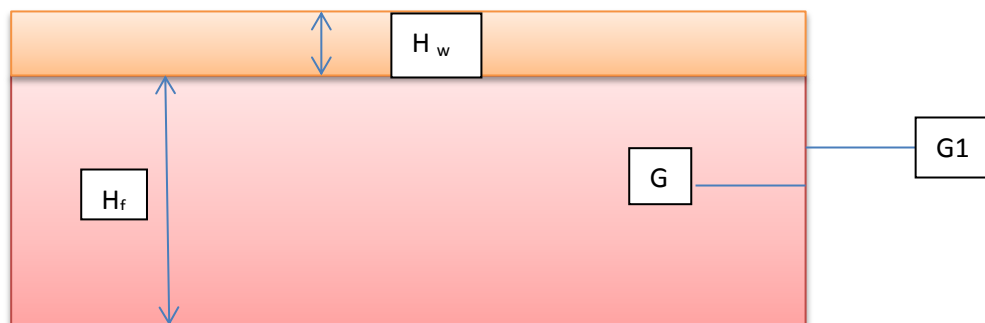

The next stage is to calculate out the position of centroid with combining of the dry part, G2. To simplify the calculation, another assumption had made here.

Assumption: Since the loading weights attached to the free wheels, the downward force from the weight would be directly adding on the flywheels. Therefore, the mass of the dry parts will now include the submerge parts, which is 2.8 kg + 4 kg = 6.8 kg. Figure 3.2 below shows the full layout of the device.

Figure 3.2 Full layout of the device

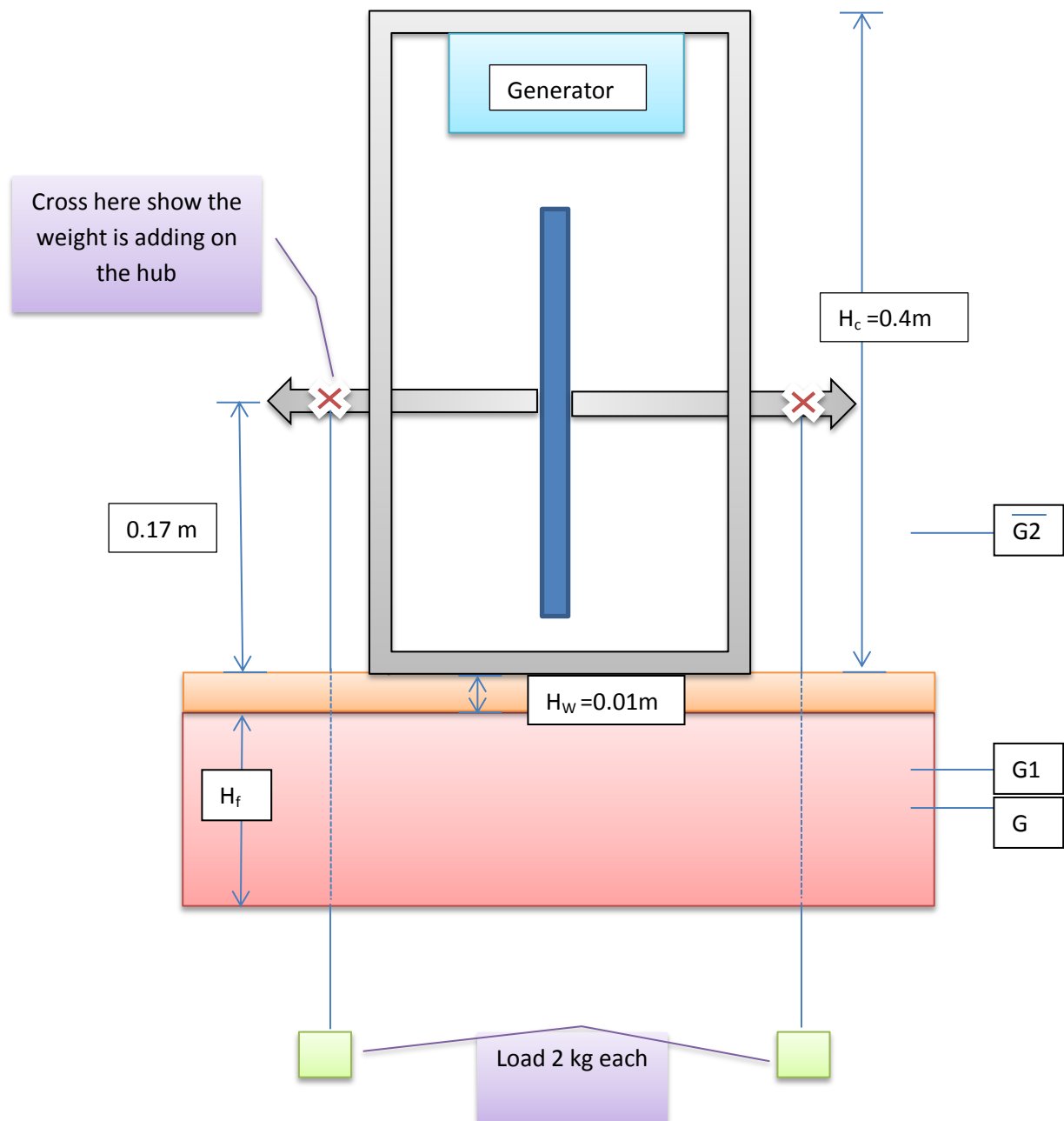

To find out the position of G_2 , the concept of formula (3.1) above can be re-apply again.

$$G_1G_2 = w_1 * d_1 / (\text{Total mass}) \quad (3.2)$$

Let w_1 be the total mass of the dry part, which is 6.8 kg from above, and d_1 is the centroid distance between both parts, can calculate by (total height of the foam and pinewood - G_1 + $H_c/2$), and see equation (3.3).

H_c in figure 3.2 above is it the height of the outer frame, 0.4 m. This implies the centroid of the dry part is $H_c/2$.

$$d1 = (Hf + Hw - G1) + (Hc/2) \quad (3.3)$$

To calculate the exact central of gravity, all the components would be taken into account. For example, the G for the generator, wheel, hub etc. and then recalculate the position for the new G. Method above is only providing an approximation of the central of gravity for this device.

3.2.2 Calculation of metacentre

For section 2.3, Archimedes' principle states that the upward buoyant force exerted on a body immersed in a fluid, whether fully or partially submerged, is equal to the weight of the fluid that the body displaces, hence

$$F_b = \gamma(X * B * L) \quad (3.4)$$

Parameter of the equation above:

- F_b is the buoyancy force acting on the device, at the equilibrium position, F_b is equal to the weight of the device.
- B is the beam and L is the length of the floating foam. B times L gives the cross sectional area of the foam. For this device has a hole in the centre, hence the cross sectional area is replaced by $(B_{out} * L_{out}) - (B_{in} * L_{in})$.
- γ is the specific gravity, which is the density of the water times acceleration due to gravity. Can represent as $\rho * g = 1000 * 9.81$ X is the draft of the device.

In order to find out the metacentre, first we need to identify, by rearrange the formula (3.4), it gives

$$X = F_b / (\gamma * B * L) \quad (3.5)$$

The next step is to compute KB , where KB is the centre of buoyancy height above the vessel keel, since buoyance of the float is a box shape therefore KB is half of the draft.

$$KB = X/2 \quad (3.6)$$

KG is the distance from the Keel of the device to the centroid, which is $G2$ in this case. It was found in section 3.1m

BM is the height of the transverse metacentre above the centre of buoyance which show as the formula below

$$BM = I / Vd \quad (3.7)$$

I = the second moment of the water-plane area about the centre line, for a rectangular water-plane area the second moments about the centre line (I) can work by the formula:

$$I = B^3 * L/12 \quad (3.8)$$

But for this case the foam had a hole in the middle, I needed to replace formula (3.8) by

$$I = A = [(L_{out} \times B_{out}^3) - (L_{in} \times B_{in}^3)]/12 \quad (3.8.1)$$

V is the ship's volume of displacement, which is the draft times the

Hence,

$$BM = \frac{[(L_{out} \times B_{out}^3) - (L_{in} \times B_{in}^3)]}{12 \times Vd} \quad (3.9.1)$$

If KG is higher than BM the device will be unstable and sink.

3.3 Calculation result

For this experiment, a basic rectangular box shape has selected in order to see how would the device response of the device under regular waves with respect to different amplitudes and frequencies. A rectangular shape box allows water to pass though on the side, therefore the device is always facing the wave. Though the experiment, further investment can develop on this basic shape.

To get a better view on the device, the experiment is going to be tested in different layout, i.e. different side of the platform with different loading on it.

For this design, the foam started with a height of 0.1m, and increases by 0.05m by each interval up until the height of 0.4m. Therefore, here have 7 different heights been produced for the foam. For the cross sectional area, the hole has an area of 0.173m x 0.363m, began with a length of 0.05m from the side of the hole, then increase by 0.05 for each interval until it has a length of 0.5 m on each side. Hence we have 10 different designs for the cross sectional area. Table 3.2 below shows the example of the buoyancy results basic on the calculation method from section 3.1 and 3.2 above.

Calculation results can be finding in appendix A. The result shows most of the scale would be able to support the device without skinning. The metacentre of the buoyancy increase gradually as the height of the foam increase until it reached the height of 0.3m and then deduce after, this tells us the platform is getting more stable as the height of the foam increase. Since we are trying to get the maximum heave for the device, the 0.3 meter height had been selected for the experiment.

(All calculation show in appendix 1)

Final design

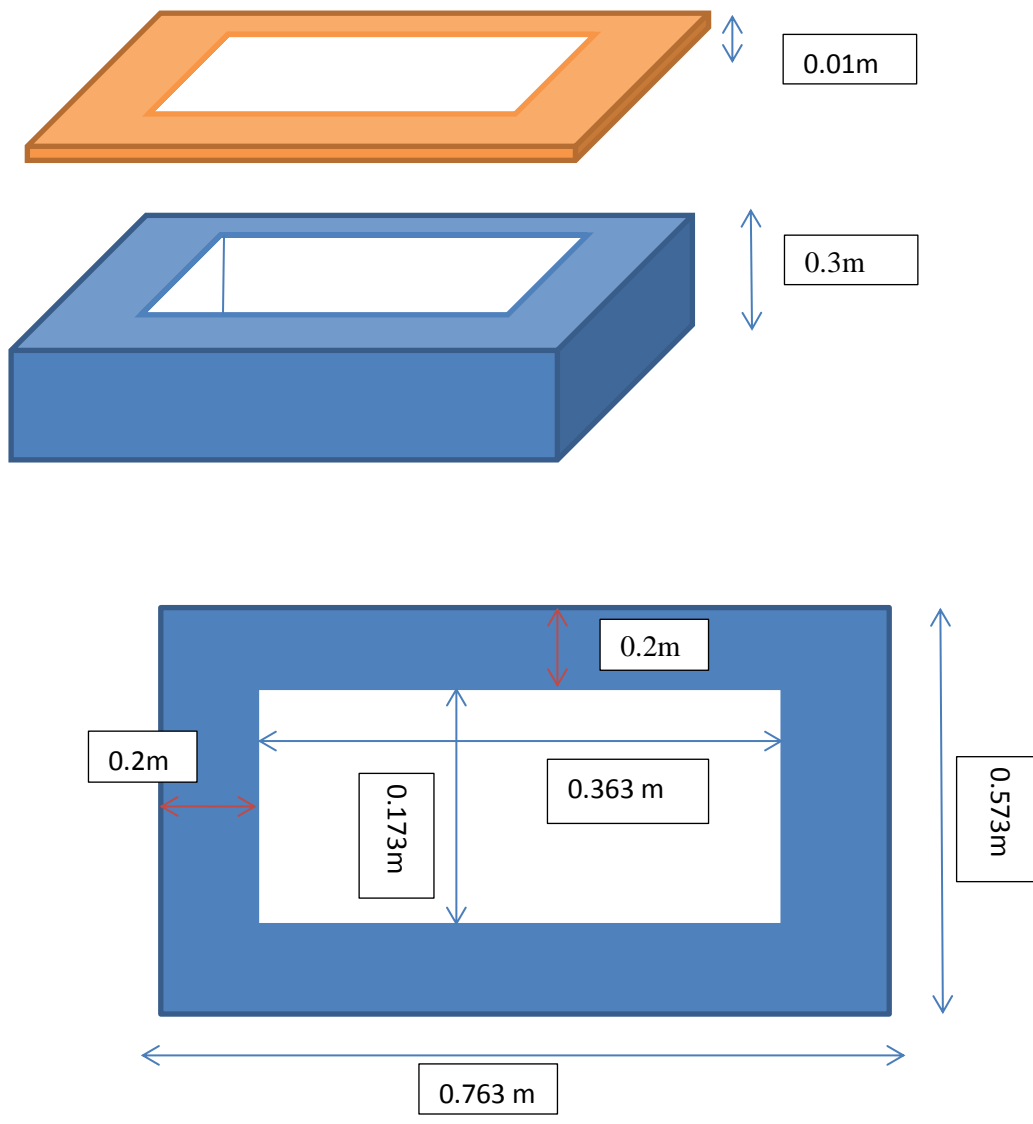

4.0 Test methodology

4.1.0 Background

The experiment tested in Newcastle University, marine technology department by using the wind, wave and current tank. This experiment was primarily testing how is the wave energy converter response to some with regular waves with a different range amplitudes and frequencies.

Although the water current would be one of the essential factor for the device, due to the limited time of the experiment, this experiment would only concentrate on wave. Current only be tested on the last day of the experiment; also the current data would only use for future reference, and they would not be comparing to the rest of the result.

For this particle experiment, maximum frequency could produce from the tank was 1.25 Hz, and the limited for amplitude is 0.45 m. The test was running for a week, Monday till Friday 9am till 5 pm. The first day of the experiment, it was mainly setup and trial before the actual experiment.

Since this is a primary test for the device, it is an advantage to have an equivalent pair for the test. Before expending the idea in lots of direction, it is better to narrow down the variation, would be able to point us to a clear direction for the future development.

4.1.1 Test matrix.

To have a comprehensive review of the device, the experiment would run under four different set of settings. Each setting would test with 5 different frequencies, and for each set of frequency would test with 4 different amplitudes. Therefore, there would be a combination of 20 tests per setting. Table 4.1 is the test matrix of this experiment.

Table 4.0 Test matrix

	730*540 mm	628*440mm
2 Kg	Date: 16/07/2013 With water draft : 40 mm	Date:19/07/2013 With water draft : 60 mm
3 Kg	Date: 17/07/2013 With water draft: 55mm	Date:18/07/2013 With water draft : 75 mm

The table 4.1 below is an example of the sub-matrix, the vgen16 represent the setting with refer to the experiment day. Finished box is rather quite an import step to have as and security check. With the high amount of data, sub-matrix is a very good way to keep the data organizes.

Table 4.1 Sub- test matrix

Date : 16/07/2013 (vgen16)			
Test number	amplitude	frequency	Finished
test 1	0.015m	0.25hz	
test 2	0.025m	0.25hz	
test 3	0.035m	0.25hz	
test 4	0.045m	0.25hz	
test 5	0.015m	0.5hz	
test 6	0.025m	0.5hz	
test 7	0.035m	0.5hz	
test 8	0.045m	0.5hz	
test 9	0.015m	0.75hz	
test 10	0.025m	0.75hz	
test 11	0.035m	0.75hz	
test 12	0.045m	0.75hz	
test 13	0.015m	1hz	
test 14	0.025m	1hz	
test 15	0.035m	1hz	
test 16	0.045m	1hz	
test 17	0.015m	1.25hz	
test 18	0.025m	1.25hz	
test 19	0.035m	1.25hz	
test 20	0.045m	1.25hz	

4.2 Pre- Setup

Since the test was running inside a water tank, setting up for the experiment would require someone to work inside the tank, to make the setup smoother we had a pre-setup on grand, before sending the device into the tank.

Section 1.1 mentions the device had 3 main parts, to combine these parts together required some ropes and chains, by colour coded and mark down the connection point of the chains and ropes on land, it reduces the confusion in the water and also direct the person to connect the parts at the correct positions. For example, the free weight should be positioning at the mid tank height. Which is about 0.75m from the water surface, the marking would be prevent measurement inside the water tank.

Weight section, is a very important part for this experiment. Since the tank was made by glass, heavy metal might damage it. Lead is one of the best objections for this test, because it is a soft and malleable metal, which is regarded as a heavy metal and poor metal. For further protection, the lead was raped with a thin layer of gaffer tap to cover any sharp corner. Another issue with the load is they don't have the same shape. Although the scale of

them is the same but the shape of the load might have a significant affect during the experiment.

Electrical power output is what this test is mostly interested. For this analysis, we had installed an amplifier at the top of the frame and connected to the generator, (positive and negative ends need to be check before connected to the generator). Other things that we are interested in the test are how the acceleration effect on the power output, to monitor that an accelerometer has placed on the frame too.

4.3 Setup and trial test

After completed the pre- setup, we let the device settled in the tank. To minimise the losses, the team made sure cables connected to the reader do has a nice hyperbolic hanging curve so that they would not tension the device waves are passing through the device. See figure 4.0

Figure 4.0

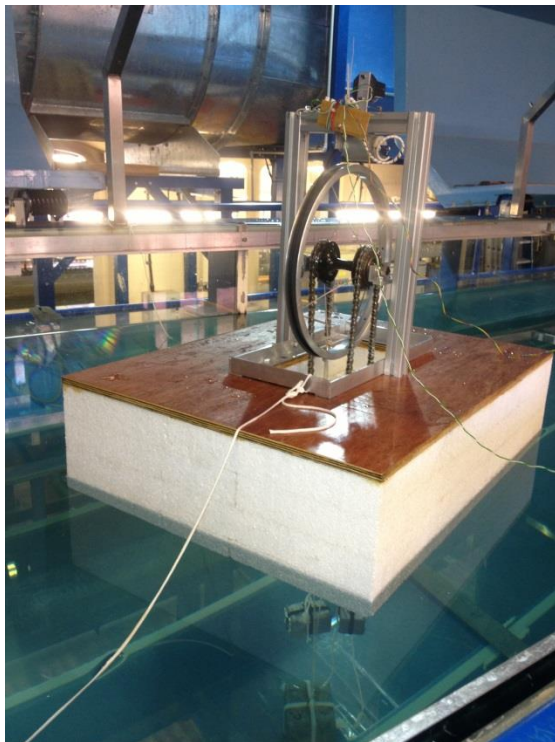

Figure.4 shows basic setup for the trial test. From the picture, at the very top of the device is the accelerometer that measures the acceleration of the device in up and down direction and a generator just above the wheel.

Dominate weight was sitting at the bottom of the tank and loading weights was the position around mid-height from the water level.

The green and white cable which was the connection between the generator and amplifier. The green, yellow and red cable is for the accelerometer. Those cables were hanging down with a nice curve of without interference the water surface and the movement of the device.

The trial test started with 2 Kg load on each side and with relatively high amplitude of 0.35 m. This gives us a good estimation if the floating would be able to support the entire mechanic. Also, it could provide a good estimated of how much energy it will produce. For the first trial, we observed the energy production were too low to read, in order to recall the data. The size of the resistor had been reduced and allows the current to pass through the amplifier. The scale on the computer had also been adjusted to mill watts.

As the trial test goes, the free load started to twist onto the central rope which connected to the dominate weight. By adding a tube around the dominate weight to prevent the twisting, on the downside the loading weight was rubbing against the tube i.e. energy lost. To resolve this problem, the free weight was tightened against the device; this helped to reduce the friction between the free weight and the tube. Tension would have an effect on the device, hence reduce the efficiency. Figure 4.1 shows the twisting on the left hand side and the added tube on the left hand side.

Figure 4.1

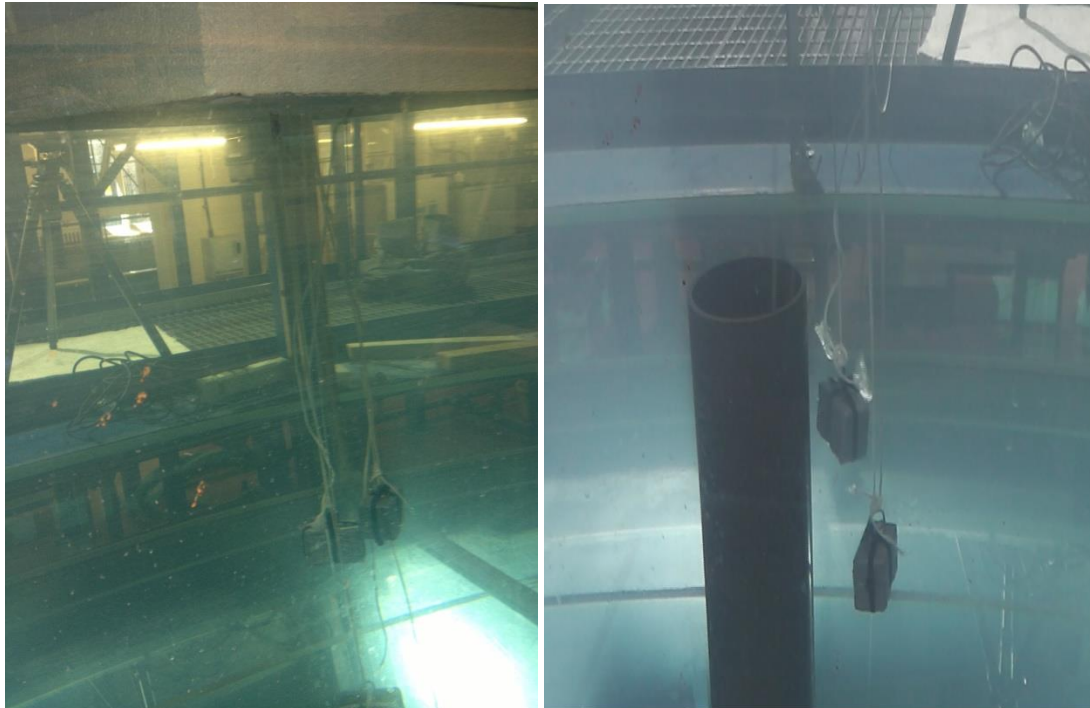

Further observation of the trial, the height of the foam was 0.4 m; this provided a high floatation and a high stability for the device. With a high metacentre of the device, it would not be capsizing easily; instead it has a very rocky movement. In fact the floatation was so high; it could support the weight of a man. With this high amount of floatation would reduce the heave motion of the device.

Based on this factor, the height of the foam had been reduced by 0.1 m. The draft has a significant increase from approximate 30 mm to 40 mm. Although the depth of the foam reduced to 0.3m, the flotation still firms enough to support the device. After depth of the foam had been shortening, the rocky movement has also been reduced and replaced by a bigger heave movement.

Another problem has we could see from the trial was the turning effect. In some occasion, the device tended to have a yawing motion. When a wave hit the length of the device, it would have a rolling motion, which is useless to device. To reduce yaw, we attached two pieces of robes from the device to side of the tanks to guide the device with it over turned. Again, the robes were hanging with a nice hyperbolic curve, to prevent the tension on the strings.

5.0 Data analysis

5.1.0 Introduction of data and over view

We collected the total of 80 data from the experiment, for each data, it has the measurement of four parameters, which are wave height before and after the device, acceleration and the power. Acceleration was recalled by an accelerometer, which measures in G, to convert G to m/s^2 just divide the value by 5 and time by 9.81. All the data recalled with a 30 second period with 0.01 second interval per reading, hence 3000 variables per parameter.

The 3 figures below are the results from sample 180713test11. Figure 5.1.1 is the wave height, measured by the wave pole. The graph shows that the wave took about five second to reach the first pole, and form a series of sinusoid wave. The graph also suggests that there is some interference in the tank, there is a slice decrease of the wave height at 1728. This could be the reflection from the device.

Figure 5.1.1 Wave in

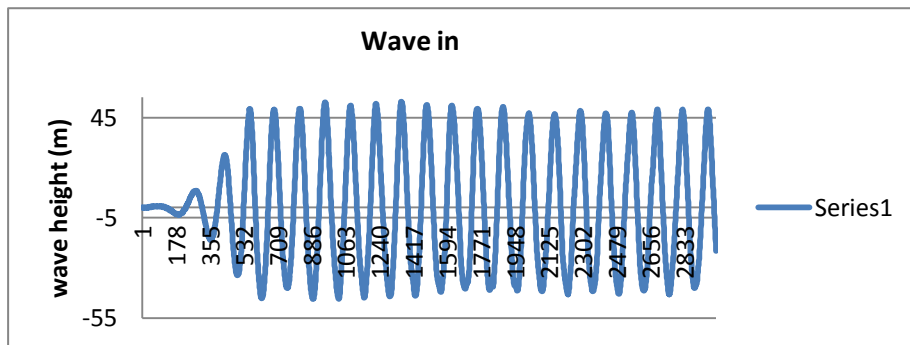
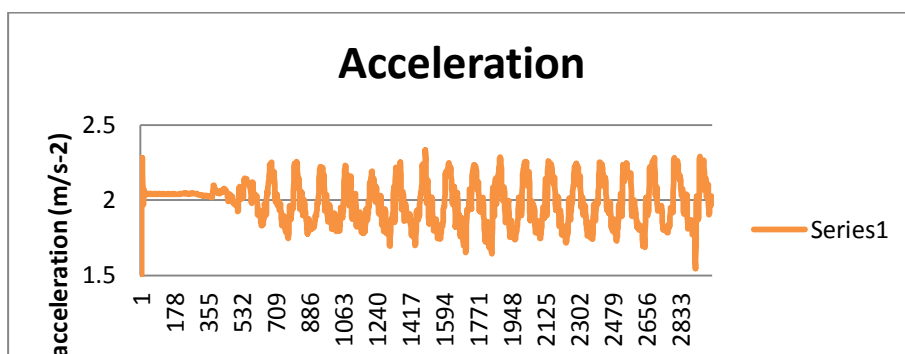

Figure 5.1.2 shows the vertical acceleration acting on the device. There is a delay reading compared to the wave height graph, although the graph has a sinwave path, but there are a lot of noise throughout the reading. And notice the reading has an offset from the data.

Figure 5.1.2 Acceleration



The last graph is figure 5.1.3, which represents the power output from the generator in mill watts. It also has a delay against the acceleration. Once more it has a sin wave pattern. Based on the graph, we can see a constant electricity output and a significant amount of zero distribution.

Figure 5.1.3 power out put

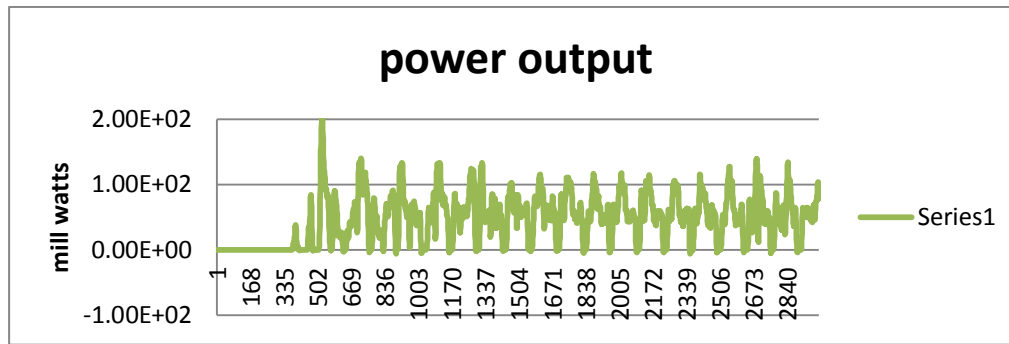

In order to a constant reading, we are going to exclude the first five second. The following analysis would be concentrate in test12, because most of or device has the best response this particular frequency 0.75Hz and amplitude 5m (see the explanation in the following section 5.) Analysis would be spited into mathematic modelling and statistical tests.

5.2 ANOVA

Analysis of variance (ANOVA) is a collection of statistical models used to analyse the differences between group means and their associated procedures. By applying ANOVA, it give us an idea there and different in term of the **power output**. The statistical tool we are going to use here is R.

We divided all 80 data into 20 groups, from test1 to test20. Each group has the same amplitude and frequency, which can refer to table 3.2. Vgen16 to vgen 19 are the test level for each group, they are representing the different layout of the experiment (, see section 4.2, tables 4.2.) The levels are independent, and the variances are dependent to the level.

Figure 5. Test1 data

	A	B	C	D	E
1	vgen16	vgen17	vgen18	vgen19	
2	4.60E-05	4.60E-05	4.60E-05	4.60E-05	
3	0.000305	0.000305	0.000339	0.000339	
4	0.000983	0.000949	0.001203	0.001169	
5	0.002157	0.001937	0.002805	0.00255	
6	0.003711	0.003063	0.004947	0.004045	
7	0.005347	0.004111	0.007173	0.00507	
8	0.006701	0.004875	0.009019	0.005309	
9	0.007614	0.005296	0.010199	0.004854	
10	0.00818	0.005595	0.010672	0.004162	
11	0.008567	0.00604	0.010557	0.003844	

Before we apply the AVONA, it is important to look at the data distributed. Figure 5.2.2 is the summary of the test12 and figure 5.2.3 is the boxplot of the data. It shows us the mean and median of the power . Boxplots are a good way to present the data graphically.

Figure 5.2.2 summary of test12

```

> plot(tk12)
> test12<-read.csv("test12.csv", header = TRUE)
> summary(test12)
      vgen16      vgen17      vgen18      vgen19
Min.   : -7.327   Min.   : -7.898   Min.   : -6.468   Min.   : -6.022
1st Qu.: 35.265   1st Qu.: 22.333   1st Qu.: 36.167   1st Qu.: 36.976
Median : 50.164   Median : 56.047   Median : 54.012   Median : 55.235
Mean   : 53.789   Mean   : 54.797   Mean   : 54.841   Mean   : 56.220
3rd Qu.: 69.598   3rd Qu.: 78.087   3rd Qu.: 75.065   3rd Qu.: 74.812
Max.   :166.709   Max.   :156.887   Max.   :208.786   Max.   :202.402
      X
Mode:logical
NA's:2501

```

From the summary table above show the mean of the data set are pretty close, and the data range is high as well. If we look at the boxplot below, first thing can observe is the outlier of each group. Outlier is one appears to deviate markedly from other members of the sample in which occurs. In this case it represents the peak value that generate from the data. The things there we are interesting in is the range between the first and third quarter, the closer it is means the electricity output is more constant.

Figure 5.2.3 Boxplot of test12

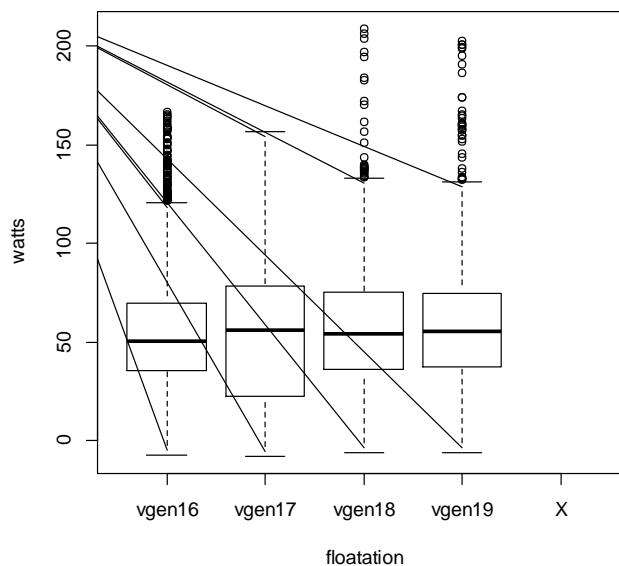

The figure above suggest all the data have a very similar type of variance. Veg18 and veg19 have a almost identical behavior. The variance of Veg17 are spreaded quite widely. The graph for vgen16 shows it has a very consist output but it also large amount outlier.

Refer to the figure 5.2.4, the power output graph. It clearly show the how the boxplot relate to the power output. For vegn18 and vgen19 has a constant period which are repeating them-self, which is why the quarter are narrower that vgen17. Vgen16 has a very constant start then varies after. For vgen17, the has a high peak value, but it is not consistent.

Fugire 5.2.4

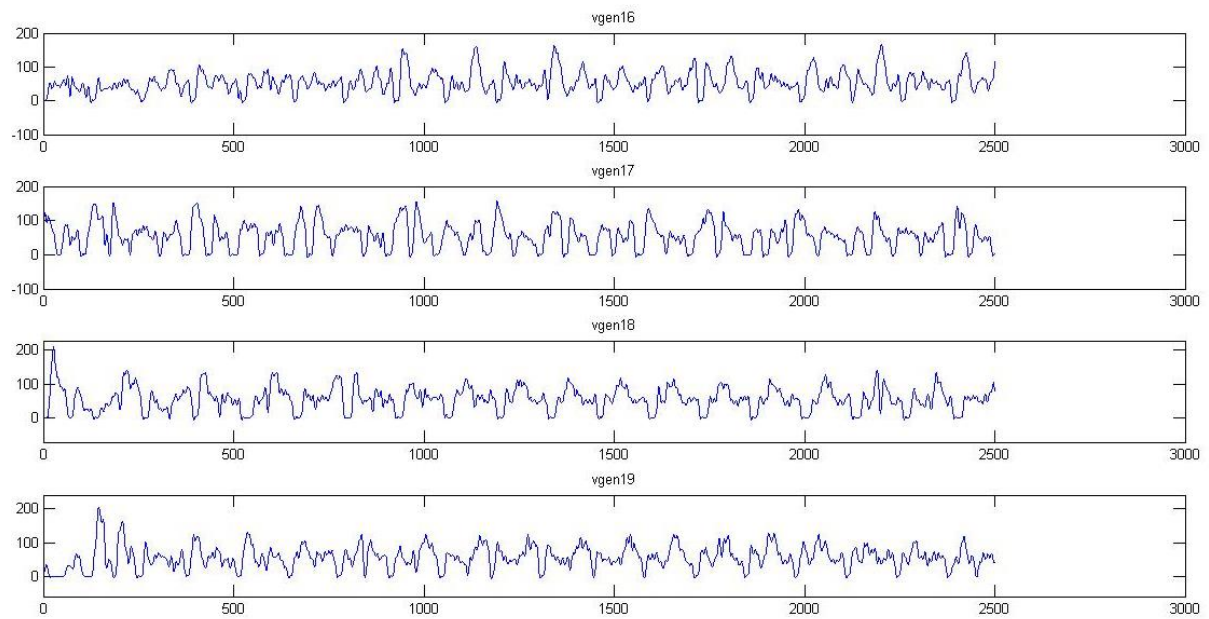

all boxplot and the the power graph are in the appendix 2

5.1.0 ANOVA analysis

Since the ampitudite and freqency provided for each level are the same, therefore the power output form the device should be similar . we can set the hypothesis as:

$$H_0 = \mu_{\text{vgen16}} = \mu_{\text{vgen17}} = \mu_{\text{vgen18}} = \mu_{\text{vgen19}}$$

Or

$$H_{\mu} = \text{They are all different}$$

```
> av12<-aov(watts~floation,data=sttest12)
> summary(av12)
              Df    Sum Sq Mean Sq F value Pr(>F)
floation      3      7482    2494    2.055  0.104
Residuals 10000 12137752    1214
2501 observations deleted due to missingness
```

From the output we see that the p-value is 0.104, this indicating that the settings of the device have no significant effect on the power output. This is desirable since the amplitude and the frequency of the experiment is the same. Also in the table we see that the ANOVA p-value for the type is highly significant, indicating the difference between power output. So from now on we can make the Tukey test to see where the differences lie.

Tukey's HSD (honestly significant difference) analysis, or the Tukey–Kramer method, is a single-step multiple procedure and statistical analysis. It used in conjunction with an ANOVA to find means that are significantly different from each other.

```

> tk12<-TukeyHSD(av12)
> tk12
  Tukey multiple comparisons of means
  95% family-wise confidence level

Fit: aov(formula = watts ~ floation, data = sttest12)

$floation
          diff      lwr      upr    p adj
vgen17-vgen16 1.00768773 -1.5237647 3.539140 0.7360685
vgen18-vgen16 1.05174061 -1.4797118 3.583193 0.7093624
vgen19-vgen16 2.43143882 -0.1000136 4.962891 0.0650743
vgen18-vgen17 0.04405288 -2.4873995 2.575505 0.9999679
vgen19-vgen17 1.42375109 -1.1077013 3.955203 0.4711264
vgen19-vgen18 1.37969821 -1.1517542 3.911151 0.4990667

```

95% family-wise confidence level

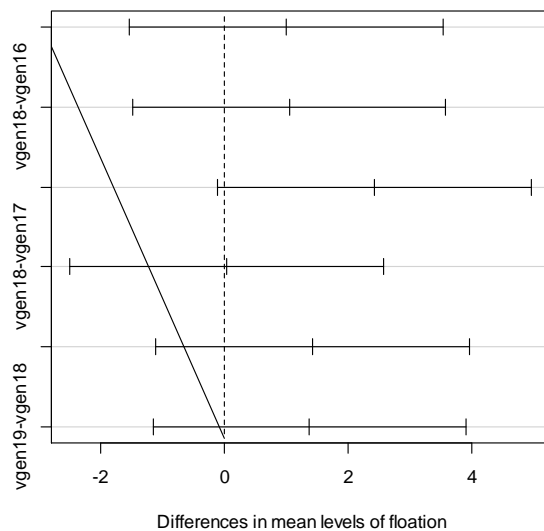

One can see that only the confidence interval for all of them contains 0. Thus, it appears that they are not differ among themselves, but are different from brand control

5.2.1 Further discussion

This table is a list of all the power output mean value for the experiment. Based on the mean value, it suggest the veg17 and vgen 18 has dominated most of the time, and it show that **vgen 18 test7** has the best result among the entire test.

Table 5.1 the mean values of the test

		vgen16	vgen17	vgen18	vgen19
0.25Hz	test1	6.83	8.83	5.11	5.51
	test2	18.9	23.07	15.12	18.51
	test3	25.29	37.31	27.69	27.68
	test4	26.38	56.18	42.97	34.07
0.5Hz	test5	16.96	40.98	23.139	24.67
	test6	19.85	60.58	48.22	44.02
	test7	26.13	65.78	48.22	48.43
	test8	42.8	57	68.58	49.55
0.75Hz	test9	25.09	17.61	32.95	26.87
	test10	35.6	49.06	55.24	46.29
	test11	48.23	58.91	65.35	53.18
	test12	53.79	54.8	54.84	56.22
1Hz	test13	17.36	0.0188	12.16	17.08
	test14	42.65	16.4	36.76	29.22
	test15	47.148	41.22	46.77	40.02
	test16	49.18	43.541	49.67	40.87
1.25Hz	test17	6.68	0.095	2.79	2.48
	test18	25.6	19.68	11.12	20.43
	test19	27.58	24.92	17.26	27.85
	test20	34.766	30.43	5.98	9.86

By using Anova, we know that there are some differences in between setting, and Form the data above, the setting with 6 kg loads definitely has a better preferment. It suggests the power output is depending on the weight of the load rather than the size of the platform. Can see from appendix 2, vgen 16 and Vgen 19 are dependence to each other most of the time.

This is the power distribution vgen18 test17.

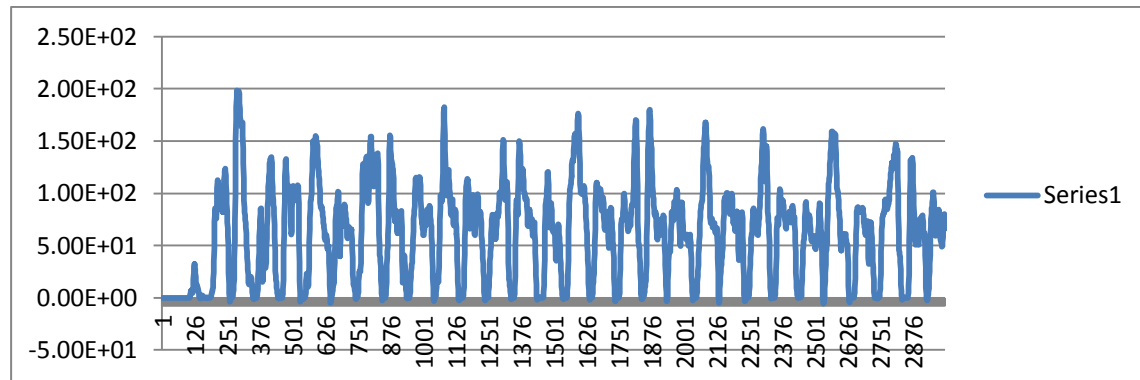

Interesting factor in vgen 18 test 5, 6, 7 and 8, the device was actually was turned 90 degree against the wave, in fact from the record book. And yet their energy output is a lot higher compare to the others. (Further discussion will see in chapter 6.)

5.3 Mathematical modelling

In this section, we are investigating efficient the device is, to achieve that we have work out the wave power and energy in table 5.3. The calculation based on the equations from section two, therefore the energy is measure in joules per unit length and power is measure in watt per meter.

Table 5.3

	a=0.015 m		a=0.025 m		a=0.035 m		a=0.045 m	
Frequency (Hz)	Energy (Joules)	power	energy	power	energy	power	energy	Power (w/m)
0.25	0.29	3.45	0.80	9.57	1.56	18.76	2.58	31.02
0.50	0.07	1.72	0.20	4.79	0.39	9.38	0.64	15.51
0.75	0.03	1.15	0.09	3.19	0.17	6.25	0.29	10.34
1.00	0.02	0.86	0.05	2.39	0.10	4.69	0.16	7.75
1.25	0.01	0.69	0.03	1.91	0.06	3.75	0.10	6.20

From the table, we can see most of the energy and power is concentrating at lower frequency and high amplitude range. The also suggesting with a longer wavelength would carry more energy. For the above section we have seen the mean average output of each test, the result that we have got is very little indeed, in fact one of the highest average we have got is from vgen18 test 8, which has an output of 65.7 mill watts, compare back to the table above with the equivalent amplitude and frequency, it has the 15.1 w. This mean the efficient of our device is about 0.44%

As this paper is working on the device with a floating platform, it is very interesting to know how much force or energy has it capture by just the platform. To do that, we can look into the heave motion of the device.

In section 2, we know the equation for heave is $(M + M_a)\ddot{z} + b\dot{z} + cz = F_o \cos(\omega t)$, therefore if we want to find out the force, we need to find the velocity and displacement.

First here we can find out the mass and added mass and the restoring force, which is the draft difference over the added weight which is $(0.075-0.055)/2=0.01$. To calculate mass and added mass we can use the formula for section 2.7. Table 5.3.1 is the result of the calculation.

Table 5.3.1 mass and added mass

added mass	(Kg)				
bigger	79.32669616				
smaller	47.58372983				
4 kg	mass of foam	mass of wood	device	load	(Kg)
bigger	2.789733618	1.7564253	2.8	4	11.34616
smaller	1.997431458	1.2575893	2.8	4	10.05502
6kg	mass of foam	mass of wood	device	load	
bigger	2.789733618	1.7564253	2.8	6	13.34616
smaller	1.997431458	1.2575893	2.8	6	12.05502

Since the acceleration was captured in the experiment. By integrating the acceleration twice, we would get to the velocity and displacement. As we mention earlier, the accelerometer was proportional to the G, to transform the data to m/s^{-2} we need to times it divide it by 5 and time it by 9.81. As we mention from above the data has an offset, which need to refer back to zero by taking away the mean value of the data.

From figure 5.1.3 we notice there is a high amount of noise from the acceleration data. Therefore before the integration, is better to filter out these noises. To do that we can use a Matlab function call "butter " see figure 5.3 below.

Figure 5.3

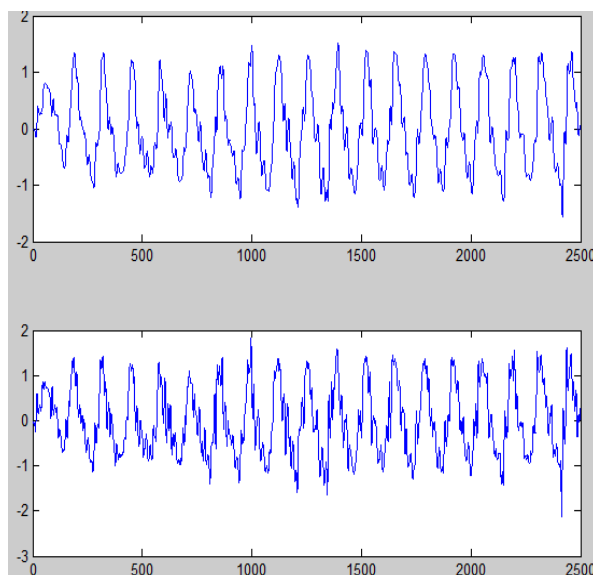

After we filtered out the noise, we can apply the integration by trapezoidal rule. Assumes $n=1$, that is, the area under the linear polynomial is, we have the $\Delta t=0.01$, by using Matlab we get

$$\int_a^b f(x)dx = (b - a) \left[\frac{f(a)+f(b)}{2} \right] \quad (5.1)$$

Figure 5.4 Acceleration velocity and displacement graph

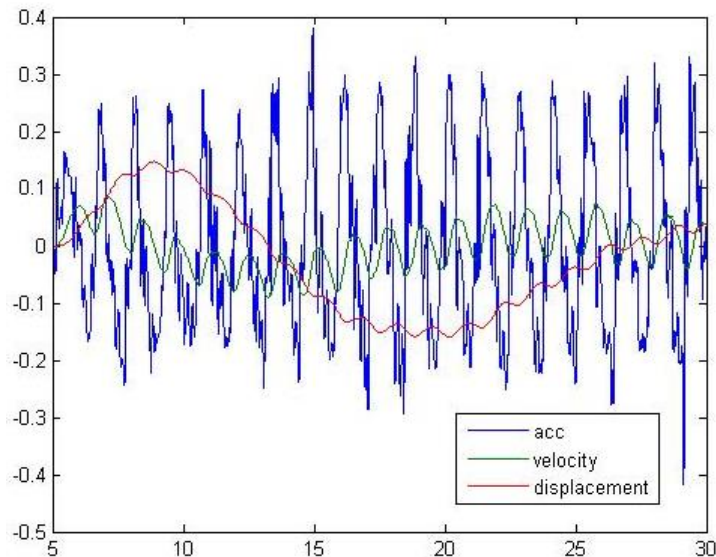

The displacement of the graph is not on zero, this suggest the first quarter has a stronger positive accelerations and a decreased after. This happen is because the acceleration is not perfectly balance on both positive and negative side. Although the offset be taken off, the integration still produces a straight displacement. Since the offset been has taking off, the end the displacement will always starts at zero and return back to the zero in the end.

To make sure we were using the right commend in Matlab, we had produced another graph from excel by using same method. Although it is not identical to Matlab displacement, but they definitely has the same pattern.

Figure 5.5 acceleration velocity and displacement graph, with excel

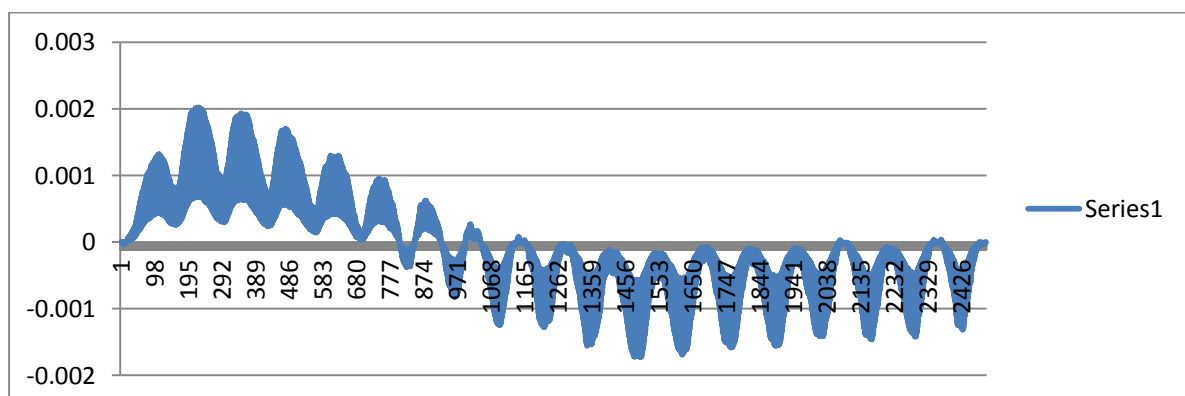

By some reason the line was rather thick, this might be the fact that we include the noise in the calculation.

Therefore instead of using the integration, we can work out the heave force by the pressure equation, as we know force = pressure time area. From Module spg8010, we know that the pressure for water is

$$P = \frac{\rho 2\pi^2 H}{k^2 T^2 d} \exp(dk) \cos(kx - \omega t) \quad (5.2)$$

And rearrange it to get

$$P = \frac{\rho g H}{2} \exp(dk) \cos(kx - \omega t) \quad (5.3)$$

These equations can be found in the equation sheet at the end of the report.

Force is just area times the equation above. We get the following result. BP there is stand for bigger platform and the SP is the smaller platform. Also for each platform, it contains 2 set of weights as it shows below.

5.3.2 The heave force motion by using the pressure equation for the bigger platform

	force*cos(ωt) (N)							
BP	a=0.015		a=0.025		a=0.035		a=0.045	
Hz	4kg	6kg	4kg	6kg	4kg	6kg	4kg	6kg
0.25	48.3	48.1	80.5	80.2	112.6	112.2	144.8	144.3
0.5	46.8	46.1	78.1	76.9	109.3	107.7	140.5	138.4
0.75	44.5	43.1	74.2	71.8	103.9	100.5	133.6	129.2
1	41.5	39.1	69.2	65.1	96.9	91.2	124.5	117.2
1.25	37.9	34.5	63.2	57.5	88.5	80.5	113.8	103.5

5.3.3 The heave force motion by using the pressure equation for the smaller platform

	force*cos(ωt) (N)							
SP	a=0.015		a=0.025		a=0.035		a=0.045	
Hz	4kg	6kg	4kg	6kg	4kg	6kg	4kg	6kg
0.25	34.4	34.3	57.3	57.2	80.3	80	103.2	102.9
0.5	32.9	32.5	54.8	54.2	76.7	75.9	98.6	97.6
0.75	30.5	29.8	50.8	49.7	71.1	69.5	91.4	89.4
1	27.4	26.3	45.7	43.9	64	61.5	82.3	79
1.25	23.9	22.5	39.9	37.5	55.9	52.5	71.8	67.5

By using the table, we can estimate the force acting on the platform at a particular time. Although the integration does not turn out the way that we want it to be, but we can still compare the power input and power output from our data.

5.3.4 Table Efficiency table

	vgen16	vgen17	vgen18	vgen19
test1	0.20	0.26	0.15	0.16
test2	0.20	0.24	0.16	0.19
test3	0.13	0.20	0.15	0.15
test4	0.09	0.18	0.14	0.11
test5	0.99	2.38	1.35	1.43
test6	0.41	1.26	1.01	0.92
test7	0.28	0.70	0.51	0.52
test8	0.28	0.37	0.44	0.32
test9	2.18	1.53	2.87	2.34
test10	1.12	1.54	1.73	1.45
test11	0.77	0.94	1.05	0.85
test12	0.52	0.53	0.53	0.54
test13	2.02	0.00	1.41	1.99
test14	1.78	0.69	1.54	1.22
test15	1.01	0.88	1.00	0.85
test16	0.63	0.56	0.64	0.53
test17	0.97	0.01	0.40	0.36
test18	1.34	1.03	0.58	1.07
test19	0.74	0.66	0.46	0.74
test20	0.56	0.49	0.10	0.16

From the table above it does show the device get up to about 3 percent of the efficiency. This is telling us the device has a huge area we can improve on, especial at the lower frequency range.

6.0 Discussions

For any power generation system there would have a significant amount of power lose. The following section of this paper is going to list out the losses and issues through the experiment. To make it easier to explain, they can basically split them into two categories, which are the mechanical loss and the design issues.

Although the main driving force for the device is heave but during the experiment, we discovered the device also converts some energy from the pitch motion. And from previous section we discover when the device was operation 90 degrees against the wave it has one of the best preferment.

6.1.0 Comparison

Before we look into our device, we can have a look at the similar device which had been developing for a period of time. Study their structure and hopefully we might able to apply their knowledge to our device. There are fair amount of point absorber in the market. The EMCE wet page provided a range of wave developer most of they doesn't not have a mechanical transfer system, instead they are using a linear- generator to covert the energy into electricity.

This developer is Columbia Power Technologies; the concept is to convert the heave to dive the generator in the middle. This is very similar to the device we have got. The figure 6.1.0 shows the device and it components.

Figure 6.1.0 Columbia Power

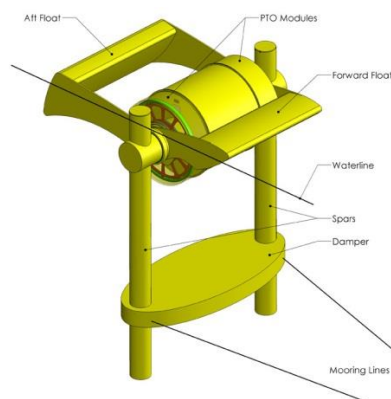

The Columbia Power most has comparatively simple design, the generator powered by the motion of the front and back float. The floats are able to move freely in the heave direction, (no extra weight added on top.) The device has minimised the moving parts of the body and a very good protection for their component special the generator. Therefore it could reduce the maintenance for the device.

According to their website, this device also has composite structure delivers strength and long life, while avoiding corrosion and single-point mooring reduces our footprint and costs. Based on the information about, we can compare with our own device try to apply some of these concepts and improve on our device.

6.2.0 Mechanical loss

This section here is going to concentrate on the mechanical transfer system. Starting with the generator, we predicated the power generated from this device would be very small, approximately under 1w. Since this model is in a small scale, it requires a relatively small size generator. But most of the generator out in the market has not got the size for this. Therefore an induction printer motor was chosen over a generator. Although it has the advantage on size, but it definitely has a lower efficiency compare to a generator. Therefore a significant amount of energy would be losing here.

Device was run by two sets of belt drive. The first set is the connection the wheel and the generator. The turning ratio of the drive is about 1:20 which is extremely high for a belt drive system, therefore a high amount of slip on the belt. From module SPG 8005, we know that the maximum is ratio is 1:6. There for we can increase the radius of the generator shaft but this will increase the input torque for the generator. The question will be is the force from the platform strong enough to power the generator.

The second belt drive is the connection between the loads and the flywheel by using some bicycle chains. These loads are move in a random direction, it will force the join of the chain to bend, and this would damage the chain of the teeth on the flywheel. Also the chain drive, it has a lot of energy lose in friction and noise as well. Another thing the size of the hole was too small, the chain was often swabbing on the side of the platform, and this is purely energy loss.

From section 5, it shows there are lot of zero distribution from the data, as we know this happen because the wheel was moving. During the experiment, we notice the wheel often stop at the peak and bottom of the wave. To avoid the happen, we can replace the pair of flywheel by freewheel or overrunning clutch. The function of freewheel is a device in a transmission that disengages the driveshaft from the driven shaft when the driven shaft rotates faster than the driveshaft.

6.2.0 Design issues

In this section is going to report on major problem with the design. Unlike the mechanical issues, these are more serious problem for the device.

6.2.1 Roping issues.

There are few issues in this design, and the major problem was roping. This design require a lot of ropes to connect different parts together, started with the setup, the amount of robes increase the confusion during setup. Addition issues like twisting happen, section 4.1 mention the ropes attached on the free wheel was twisting around the rope which connected to the dominate weight, to stop the twist, a plastic tube added during the experiment, but this created friction between the tube and the free weight. Although added a tube is one of the objection for an environment, but it is not very convenient to have a plastic tube under the sea.

In order to solve that, the number of ropes needs to be reduced or shorten, figure 6.2.0 below is an example. From figure 6.2.0 the long robes which were attached to the dominate weigh now replaced by a single robe.

If we look back into the Columbia Power design has a composite structure. Comparing to our device, ropes can easily be decay in the sea, it need to replace by some other materials. Ropes will also attract bivalvia mollusca. This will decrease the efficient of the chain, also might deliver the bivalvia mollusca into another part of the mechanic and damage the device.

Figure 6.2.0 suggestion of the roping.

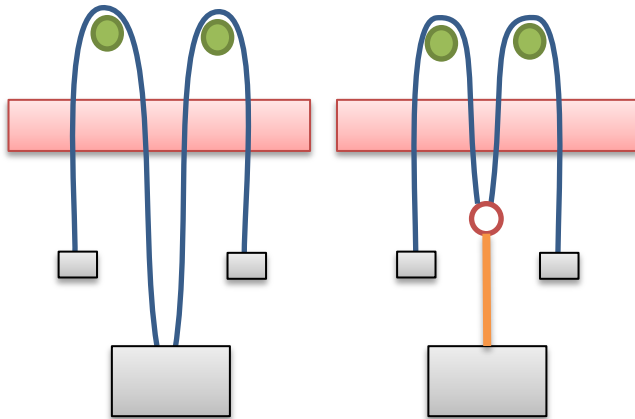

Since it is the connection for the driver; it would experience the pulling force most of the time. It is important that keep the rope in a good condition. Other material might worth to be considering for replace the rope. Flat belt shape would be a great objection to stop the twist.

For example from Gael Force, we found

Figure 6.2.1 Gael Force Libra Line



A double braided nylon rope consisting of a braided sheath over a braided core. Produced on computer controlled, state of the art production equipment, guaranteeing second to none quality and thus safety in mooring systems. For Single Point Moorings, fitting of floats and polyurethane coating of ropes will be carried out in our specialised rigging shop.

Libra Line is OCIMF certified for offshore use and also carries Bureau Veritas Certification of Type Approval.

Typical Applications: Tension winch mooring ropes, single point mooring (SPM) ropes, deep sea towing ropes, snottier ropes.

Size: 80mm - 120mm

(Reference Gael Force)

6.2.2 Protecting issues

Further issues were the lack of protection for the mechanic. When the experiment was running under a high frequency and amplitude condition, the surface of the platform has washed by waves, this increase the load on the buoyancy hence reduce the heave motion. Illustrating by figure 6.2.1, as the water washed over the deck, the belt got wet and it was too slippery to turn the generator.

Figure 6.2.1

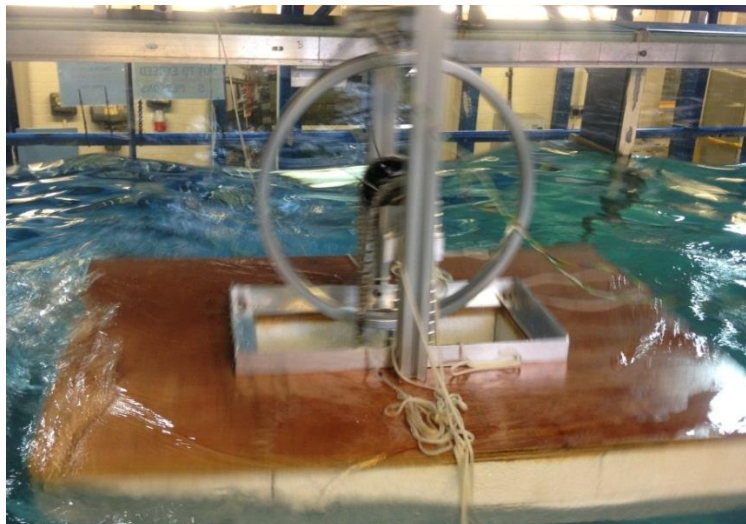

In the real sea saturation, mechanical parts need protection from different weather and sea condition, a house can be added on the, but it will decrease the buoyancy. This Lead to further issues, at this level of the experiment the component of the device is relatively light, but if the device is increase to very big scale for electricity generation, it might require a gearbox, bigger generator etc. with the amount of mechanics is going to place on the platform, will definitely reduce the buoyance force.

6.2.3 Weight issues

Two set of weights were selected for the experiment, 4 kg loads and 6 kg loads, and they are equally divided on each side. We combined two square block of the one kg weight to get a 2kg weight. For the 3 kg weight, we attached a one kg of brass on the same ring, see figure 6.2

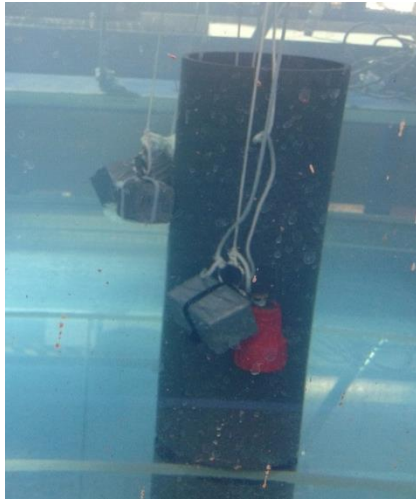
Figure 6.2.2

The original design was suggesting the size of the free weights should be different.

Although this wasn't plan to be happen, but from figure 6.2. It is clearly showed that the sizes of the free weights are not the same. Since the size are not balance, the motion of the bigger weight stared drive the platform to turn.

Further issues with the unbalance weight were it creates a tilting angle. Therefore the chain would start to scratch the side.

Additional issue of free weight is the freedom of movement. Consider with currents come from different direction, the free weights might not travel in the same direction. Imagine if the current is driving the loads in opposition direction this would reduce the heave motion of the platform, hence decrease the efficient. Since the device is operating with the heave only, it might be better to fix the movement of the weight is heave only. This might reduce a bit of efficient, but is might be than getting high amount of energy in other motions that the device does not response to.

Figure 6.2.3 below is an idea of the replace for the free weights. There are few advantages for this shape of the weight. Firstly it reduced the moving parts by combine to load into one. Secondly by combining the two weights would strengthen up the downward force without adding extra amount of mass on it, therefore it reduces the other motion. Lastly it provides a fix distance between the two points, thus it would be able to swing around and twist on the main rope and even if it starting to twist, and the weight of the load will straight up the rope. One of the disadvantages is cost of the manufacturing of this shape, without a doubt by using the 2 weight would be a lot cheaper. But this might increase a significant amount of electricity output.

The reason to have an ellipse shape is because the curve surface could reduce the force acting on it, and it is purposely design with a thicker size at the connection point. With a thicker size attach with the rope, it has a lower chance to roll.

Figure 6.2.3 design of the loading weights

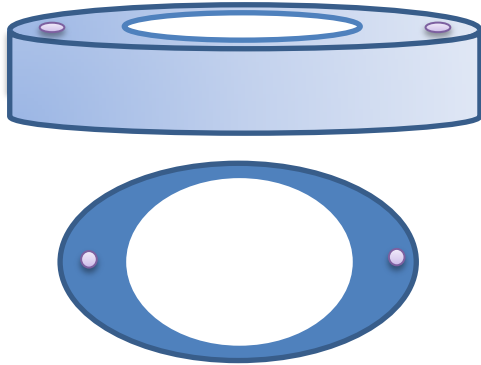

6.2.4 Flotation platform issues

For any point absorber, the floating platform is a very important to them including this device, by studying this basic shape; we have addressed some issues with the platform and areas that we can definitely improve on.

Firstly we are going to look at the movement of the platform with a low frequency. At the low frequency, platform was following in the wave surge motion instead of heave. This also affects the movement of the loads. Although The free loads was submerged in the water, but their movement was heavily depending on the motion of the platform with a phase delay, from the observation, we can see there are 2 types of movement for the free weight, up and down or a swing pendulum motion.

Pendulum motion only appears with the low frequency range, which can see by video 00126, from the video it shows the pendulum started manoeuvres the whole device. The energy converted to a driving force of the instead of electricity, the force was big enough to made the device walked down the tank.

With the high frequency and amplitude, the platform has a very big impact against the wave, due to the rectangular shape platform. The platform acts like a wall and try to stop the water to get pass it as the wave pass. Hence most of energy has transfer as a brake. Another thing that we observed is the platform has a lot of pitch motion, instead of heave; this is due to the long shape of the platform.

Therefore the platform needs to improve on its floatation and the reduction of the surge. To achieve that, the bean of the platform can be change to a curve, shows in figure 6.2.4. This allow the water to get pass the device smoothly and reduce the impact against the wave, hence reduce the energy lose. The length of the device needs to be shorted down for reducing the pitch motion.

Figure 6.2.4



For a further improvement of the floatation, an extra floating can be add on to the bottom of the platform show is figure 6.2.5. The bottom will act like a stabilizer for the platform and reduce the pitch motion.

Figure 6.2.5



Conclude what we have seen from the observation and analysis, it turns out vgen17 has the best preferment and the interesting one is vgen 18. Even with a high amount of energy lost compare to the others, it still one of the best setup for this experiment. Then we first thinking about this design, floatation is the first things that come up to the head, but often we disregard the importance of torque. And this is one of the main reasons why the vgen has one of the best results from this test.

Chapter 7.0 Conclusions

This project was a primary study of a new wave energy convertor as a renewable marine energy. Although 71 per-cent of Earth is coving by water, but the ocean still a mystery place to us. Power from the ocean is incredible, for wave only has twice the current world electricity production. It sounds like lots of energy but to harvest them is not an easy job to do.

This device we were working it with a point observer, driven by the heave motion of the wave with a pair of belt drive system. A rectangular platform has chosen for this experiment based few factors, and the main reason is rectangular is a simple shape.

Per-setup and trial was done on the first day of the experiment. During the setup, we had some problems with the ropes twisting together, to prevent this happen we added a tube to the interference between the rope but it create some friction.

Boxplot and Anova was use in our analysis, we see that there are some relation between the different layout of the experiment, and base on that we find out the most dominate layout is vgen 17 and vgen18, despite there some error in the vgen 17 data set.

For the mathematical modelling, we have some problem with the integration with the acceleration, but we found out the electrical output can get to around 3 per-cent of efficient.

Lastly is the discussion, we had point out some issues with the mechanical transmission and design issues. The main problem is the amount for moving part of the device, the moving part has a great freedom of movement will cost a lot of energy loss and damage the device.

By looking at this device for a period of time, I do agree that it has a great potential. From design, I have a notice the device is not complete depend on how good the buoyancy is; instead the torque is equally important. For the section i made a table of the mean energy output. Vgen17 and vgen18 they both carried the heavier weight. Especially from vgen18, the power output is the most constant out of other 3 sets. Since it has the smaller platform and heavier weight, the amount of energy loss is to be higher than the other.

Therefore another important thing to look at is the weight and surface area proportion. For this experiment, we did not particular study that but to find the balance of the buoyancy and the torque might able to maximum the power output.

8.0 Recommendation

Current

Since this is the primary text of this new device, there are a lots of area it can be improve, one thing we did not look at the current in detail. As the loading weigh are submerged into water. Current would have a massive effect on it. Form section 4, we mentioned the device was tested under some currents, as we predict the current would force the device like a kite hence, it limited down it's movement, and therefore less energy output, but the result as total opposite to out prediction.

In fact the energy output was high the than the computer can take, and we need the increase the resistor for capture reading. This might limited down the pitch motion instead, therefore the waves get pass, and the device is moving in heave only.

Others

Other issues we need to think are the tidal. The tidal high different on the UK's coast could up to 5ms or more. This is very important since it has 2 mechanic drives submerge in the water.

The shape of the platform definitely has a huge room for it to be improving as we mention in section 6. As we discover some time it works better with 90 degrees against the wave. This might involve minimise the area of the device.

How much torque can the floatation can the load provided it very important, therefore if can work out effect on the high scale of the load, it definitely helps to improve the device, for example as we found out the device operate the best at 0.75Hz and 0.045m, we can out the displacement of the device with different load on and try to find the limit of it.

Equation of wave motion sheets

Pressure for shallow water

$$P = \frac{\rho 2\pi^2 H}{k^2 T^2 d} \cos(kx - \omega t)$$

Added mass on a rectangular plate

$$M_a = \left(\frac{\rho}{4}\right) \pi a^2 b$$

Hydrostatic stiffness

$$K = \rho g A_w$$

Natural frequency

$$\omega_n = \sqrt{\frac{K}{M + M_a}} = \sqrt{\frac{\rho g A_w}{M + M_a}}$$

Motion response

$$Z = \frac{\left(\frac{F}{K}\right) \cos(\omega t - \phi)}{\sqrt{\left[1 - \left(\frac{\omega}{\omega_n}\right)^2\right]^2 + \left(\frac{2\omega\xi}{\omega_n}\right)^2}}$$

Reference:

Acoustics and Vibration Animations, available at:

<http://www.acs.psu.edu/drussell/demos/waves/wavemotion.html>, accessed July, 2013

European Marine Energy Centre: EMEC, available at: www.emec.org.uk/, accessed July, 2013

Carnegie wave, available at: <http://www.carnegiewave.com/index.php?url=/ceto/global-wave-energy>, accessed July, 2013

UK wave energy resource - Carbon Trust, available at:

<http://www.carbontrust.com/media/202649/ctc816-uk-wave-energy-resource.pdf>, accessed July, 2013

Renewables-atlas, available at:

http://www.renewablesatlas.info/downloads/documents/Renewable_Atlas_Pages_A4_April_08.pdf, accessed July, 2013

AWS Ocean Energy Ltd, available at:

http://ec.europa.eu/research/energy/pdf/gp/gp_events/ocean_energy/1200_aws-mkii_en.pdf, accessed July, 2013

Acceleration, Velocity and Displacement Spectra – Omega Arithmetic, Dr Colin Mercer, Technical Director, Prosig, available at :

<http://signalprocessing.prosig.com/OmegaArithmetic.pdf>. Accessed July, 2013

B. Drew, A.R. Plummer, M.N. Sahinkaya ,A review of wave energy converter technology, Proceedings of the Institution of Mechanical Engineers Part A Journal of Power Energy, 223 (2009), pp. 887–902

J. Falnes, A review of wave-energy extraction, Marine Structures, 20 (4) (2007), pp. 185–201

M.R. Belmont, Increases in the average power output of wave energy converters using quiescent period predictive control, Renewable Energy, 35 (2010), pp. 2812–2820

Gael force marine equipment, available at:

<http://www.gaelforcemarine.co.uk/c/5192/Commercial-Mooring-Rope.html>), accessed on July, 2013

Bibliography:

Count, B. and Institute of Mathematics and Its Applications. (1980). Power from sea waves: based on the proceedings of a conference on power from sea waves. London; New York, Academic Press.

Open University. Oceanography Course Team. (1989). Waves, tides, and shallow-water processes. Oxford; New York, Pergamon Press, in association with the Open University, Milton Keynes, England.

Falnes, J. (2002). Ocean waves and oscillating systems: linear interactions including wave-energy extraction. Cambridge; New York, Cambridge University Press.

Tupper, E. C. (2004). Introduction to naval architecture. Amsterdam; Boston, Elsevier, Butterworth Heinemann.

Hahn, B. D. (2002). Essential MATLAB for scientists and engineers. Oxford, Butterworth-Heinemann.

Derrett, D. R. and C. B. Barrass (2006). Ship stability for masters and mates. Burlington, Mass., Butterworth-Heinemann.

Twidell, J. and A. D. Weir (2006). Renewable energy resources. London ; New York, Taylor & Francis.

W. Bolton(1995). Fourier series; Longman.

Stade, E. (2005). Fourier analysis. Hoboken, N.J., Wiley-Interscience.

Johnson, R. S. (1997). A modern introduction to the mathematical theory of water waves. Cambridge ; New York, NY, Cambridge University Press.